

RIPPLE EFFECT

A short film pushing the limits of virtual production, technology, and COVID safety.

Ripple Effect is presented by the ENTERTAINMENT TECHNOLOGY CENTER at THE UNIVERSITY OF SOUTHERN CALIFORNIA

CREATED BY

Erik Weaver Kathryn Brillhart Greg Ciaccio Jamie McNeill Brendan Bennett Damon Laguna
Catherine Shin Nick Mitchell Manpreet Singh Halon Entertainment

TABLE OF CONTENTS

INTRODUCTION	ABSTRACT	8
	COVID-19 SAFETY	8
	VIRTUAL PRODUCTION	9
	ETC HISTORY AND MISSION	10
	PROJECT TIMELINE AND SCHEDULE	11
PROJECT MANAGEMENT	Project Structure	12
	• Objective and Test Case Design	12
	• Exploration of “Final Pixel“	14
	• Workflow #1-3 Vendor Set-Up	14
	• Workflow #2-2 Vendor Set-Up	15
	• Use Cases for Final Film	15
	Cost & Projections	40
	• Content Complexity & Scope	43
	* Virtual Production Team	44
	• Ripple Effect VP Department Roles	45
	* Executive Director & Producer of Virtual Production	46
* Virtual Production Supervisor	46	
* Pipeline TD / Workflow Supervisor	46	
* Digital Asset Coordinator	47	
• Ideal Roles (per our findings on Ripple Effect)	47	
	Integration with Physical Production Planning Systems (Project Management / Cost Tracking)	49
DEVELOPMENT	Script	50
	• Concept Art	50
	• Storyboards	51
	Script Breakdown	52
PRE-PRODUCTION	Prep Work - Director of Photography	56
	Prep Work - Production Designer	58
	Visualization	59
	• Previs	59
	* Virtual Scouting Performance Capture	59
	* Virtual Cinematography	59
	• Virtual Art Dept (VAD)	61
	* VAD Team & Skill Sets	62
	* Key Info to Include for VAD Scope of Work [from Physical Production]	62
	* VAD Pipeline	63
	Purchased Assets for Game Engine	63

PRODUCTION

**VIDEO/DATA PIPELINE,
TECHNOLOGY INTEGRATION**

POST PRODUCTION

Original Assets for Game Engine	63
Visualization VAD Pipeline	64
Final Pixel VAD Pipeline	65
* Volumetric Capture	65
Photogrammetry	65
LiDAR Scanning	66
Adding Virtual Entities	67
* Asset Optimization Process	68
• VAD for Visualization	69
• VAD for Final Pixel	69
* VAD & Final Pixel Quality	70
• Techvis	71
* Stage Alignment w/ Virtual world - Virtual & Practical Set Alignment	71
* Solving “Double” De-Focus	72
* Designing Shots for Custom LED Wall Configurations & Smart Screen	72
• Safetyvis	73
* Create Production Plans Using Game Engine Insight	73
Review Workflow	73
Real-Time	74
Integration with Physical Production Planning Systems	75
• Organize Assets in 5th Kind (Data Asset Management System)	75
• Organize Assets in ftrack (Production & Management System)	75
Testing Content On LED Walls	76
Remote Workflow in Real-Time	
• Process Per Environment	80
* Truck Sequence	80
* Dining Room Sequence	88
* Battlefield Sequence	96
* List of General Logistical Considerations	103
• LED VOLUME Operations / Staffing	103
Visibility & Observation	105
Production Insights by Department	106
• Previs and Infrastructure Planning	108
• Production Workflow	109
• Remote Monitoring and Collaboration	111
• Data Management	113
EQUINIX WORKFLOW AND TOPOLOGY	115
* Editorial	116
• Post VFX	118
* Design Full CG Shot with Halon	118
* Design & Execute Full CG Shot(s) with FuseFX	121
* “Fix it” Shots - VP Guidelines for Post VFX	121

• VP Output Ties to Post Workflows / Vendors	122
GAME ENGINE COMPARISON	122
CLOUD WORKFLOWS, MANIFEST AND ORGANIZATION ORCHESTRATION	123
JUST IN TIME SCREENING ON THE ELUVIO CONTENT FABRIC	123
• Introduction	123
• Content Fabric Technology Background	124
• Ripple Effect Process	125
* Publishing the Master Source to the Content Fabric	125
* Configuring a Site Content Object	129
* Fabric Browser Applications for Content Management on the Site	130
Object/Titles	
* Configuring Alternative Offerings	131
* Configuring Availability Profiles	131
* ML Tagging of the Ingested Content	134
CONCLUSIONS AND VIEWING	134
SAFETY ON SET	135
• Safetyvis	136
* The Team	137
* PART I - The Plan	137
Pre-set	137
On-set	137
* PART II - What happened?	138
* PART III - What we would change	140

CONTRIBUTORS

Erik Weaver
Kathryn Brillhart
Greg Ciaccio
Jamie McNeill
Brendan Bennett
Damon Laguna
Catherine Shin
Nick Mitchell
Manpreet Singh
Halon Entertainment

KEY PARTNERS



ARRI



J.L.Fisher

ILLUMINATION DYNAMICS
an ARRI Rental company

Cinema Vehicles
2015

INOVATIV



TERADEK

5thKIND

CENTRAL TECHNOLOGIES
Production Technology for Producers

miraDX

MERRICK
The Auto Dolly & Merrick original

UNDERCOVER

REALTRA, Inc.

ScriptE
Systems



LOCATION
SOUND CORP

eco'set

CFG

UDX
ULTIMATE DX

greenleaf
catering & events

SJM
INDUSTRIAL RADIO

B

colorfront

storageDNA

ftrack

PERFORCE

SILVERDRAFT
SUPERCOMPUTING

movie
labs

xsens

SAMSUNG

DIGITAL
DOMAIN

EPIC
GAMES

D/O Architects

INTRODUCTION

ABSTRACT

Ripple Effect is a short film produced by the Entertainment Technology Center at the University of Southern California (ETC). The project was commissioned to test virtual production and remote workflows, emphasizing COVID safety and acquisition of “Final-Pixels.” It serves as a case study to test critical steps for restarting and continuing film productions during COVID-19 shelter in place orders.

This paper analyzes *Ripple Effect*, sharing findings, technology highlights, best practices, and opportunities for standardization of the film’s production workflows.

COVID-19 SAFETY

In parallel to the short film, ETC physical and virtual production members designed a separate “Safetyvis” project in partnership with a visualization company to develop real-time production safety planning tools. The short film would act as an immediate testing ground to collect actual results and feedback for the Safetyvis tools and verify whether they improved safety planning for production. *Ripple Effect*’s protocols and technology allowed our COVID-19 Safety Officer to communicate and collect real data on safety workflows on set and leverage some of the same real-time, interactive visualization tools used in the production process.

In this paper, we will provide an overview of the safety tools and protocols implemented. We will provide background on the development process and the various technologies employed, detail the production process impact, and share the results and data collected.

VIRTUAL PRODUCTION

At its core, virtual production is filmmaking combined with real-time rendering, including game engine technologies to facilitate the process. The term, however, can be used to describe an incredibly varied range of evolving production techniques.

It could be anything from just using a game engine for pitch-vis, or for basic shot-blocking, or VFX previsualization and planning, to something akin to a photoreal multiplayer game (in VR, or not), where the game is “make a movie,” and everything in between.

In the last decade, Graphics Processing Units (GPUs), real-time rendering, and game-engine technology have become capable of rendering worlds, including virtual representations of the real world, at the level of fidelity we would expect from a traditional visual effects pipeline. Shots that once took hundreds of hours to render, can now render in real-time, at 60+ fps.

“It is inevitable real-time rendering will get to the point that it matches movie quality at some point in the next decade.”

- Kim Libreri, CTO of Epic Games

This technology now makes it possible to do things like virtual scouting of locations scanned with photogrammetry or LiDAR. Integrating motion and performance capture techniques allow creatives to immediately see the results of their work and performances, as virtual characters, in photoreal virtual environments. Adding LED screens, or walls, or entire stages lets you dynamically extend the set, including environmental lighting and reflections, resulting in “in-camera-compositing” of VFX, AKA “final-pixel” acquisition in principal photography. And this has become what is generally expected when working on a “virtual production.”

Like most things in the world of filmmaking, there’s no limit to how expensive and complicated things can be. And there are many challenges to overcome, not limited to the technology, with new skills, resources, and changes to the lines of communication and asset creation needed.

Our team leveraged real-time game engine rendering tools, techniques, and workflows to pilot various pre-production and production use cases for our major stakeholders. We were able to demonstrate virtual production and remote workflows for three specific scenarios: a Driving Sequence, an Interior Sequence, and an Exterior Sequence.

The goal for each unique workflow was to capture “final pixel” in-camera, and this required all departments to work together to create and approve their contribution to shots before and during production, including VFX. We’re creating a “Fix it in Prep” culture shift.

During our development phase, we generated a script breakdown (based on the script, concept art, and storyboards) that were then translated into previs, techvis, and a final shot list.

We incorporated visualization, virtual scouting, motion capture, virtual cinematography, and volumetric capture techniques into our pre-production workflows. We also experimented with tools such as the Glassbox DragonFly Virtual Camera System, Xsens Mo-Cap Suits, LED Walls, and Smart Stage Technology to prepare and execute final shots in-camera.

Each of the three sequences required different planning strategies and preparation. Although they shared common challenges, we had to account for each sequence's unique complexities from Development to Production.

In the following documentation, we have collected our findings to share common themes, outline team workflows, define new and changing roles, define terms, and establish best practices for virtual production, remote workflows, and COVID safety on set.

ETC HISTORY AND MISSION

The Entertainment Technology Center at the University of Southern California (ETC) is a think tank and research center bringing together senior executives, innovators, and thought leaders from the media, entertainment, consumer electronics, technology, and service industries. Along with the University of Southern California's academic resources, ETC explores and acts upon topics and issues related to entertainment content.

ETC was founded with the help of George Lucas in 1993 with the goal of bringing technology and entertainment visionaries together to collaborate on the future of entertainment technology. ETC was established with the mission to be a neutral research organization devoted to identifying pivotal, emerging entertainment technologies and creating programs to analyze and test them.

As an organization within the USC School of Cinematic Arts, ETC helps drive collaborative projects among its member companies and engages with consumers to understand the impact of emerging technology on the media & entertainment industry. ETC specifically focuses on technology development and implementation, the creative process, business models, and future trends.

ETC helps to identify new technology to address fundamental industry needs. The work supported by ETC is "pre" standardization, which encourages innovation and flexibility in the design and development process. The focus is to create pragmatic solutions focused on real-world products for the business of media and entertainment. After validating solutions in the real world, relevant technologies may then be submitted to organizations such as SMPTE for standardization and industry-wide adoption.

To be practical and realistic in its evaluations, ETC began a program of regular real-world production tests. These tests are delivered in the form of short film productions. So far, four projects have been produced under this program.

The first film, *Luna*, shot in 2014, focused on quantifying the "state of the art" in cloud production to provide a starting point for understanding the potential and limitations of cloud technologies. The second film, *The Suitcase*, shot in 2015-2016, added end-to-end HDR capture and deliverables along with live streaming 360 capabilities for behind-the-scenes capture. The third film, *Wonder Buffalo*, expanded our findings for cloud and HDR production while integrating virtual reality into a film production pipeline. With this fourth project, *Ripple Effect*, the ETC is again delving further into the state-of-the-art of content creation. Focusing on virtual production techniques using real-time rendering and cloud technologies in combination with COVID-19 safety practices to understand and overcome the real-world production challenges we face today. And to provide a foundation upon which further development and exploration can occur.

PROJECT TIMELINE & SCHEDULE

Universal Studios approved a 10-week schedule to complete *Ripple Effect*, a short film that used real-time virtual production techniques to tell the story. Our original schedule estimated we would start June 15 and end production by August 22, 2020. Although things shifted a few times during the project, we managed to expand our timeline by only one week, with the production phase ending by August 29, 2020.

Week Ending	DEVELOPMENT							PRODUCTION				POST PRODUCTION	
	6/15/20	6/22/20	6/29/20	7/6/20	7/13/20	7/20/20	7/27/20	8/3/20	8/10/20	8/17/20	8/24/20	8/31/20	9/7/20
ETC Production Schedule	START	START	START	START	START	START	START	START	START	START	START	START	START
ICVH Planning	Start Date	Perform Set-Up	Perform Set-Up	Perform Set-Up w/ Vendor	Perform Set-Up w/ Vendor	Perform Set-Up w/ Vendor	Perform Set-Up w/ Vendor	Perform Set-Up w/ Vendor	Perform Set-Up w/ Vendor	Perform Set-Up w/ Vendor	Perform Set-Up w/ Vendor	Perform Set-Up w/ Vendor	Perform Set-Up w/ Vendor
Visualization	START	START	START	START	START	START	START	START	START	START	START	START	START

Week Ending	DEVELOPMENT							PRODUCTION				POST PRODUCTION		
	6/15/20	6/22/20	6/29/20	7/6/20	7/13/20	7/20/20	7/27/20	8/3/20	8/10/20	8/17/20	8/24/20	8/31/20	9/7/20	
DIRECTORS	Work with each building location to assess materials for construction, scope assessment, and risk assessment. Provide direction to ICVH for standards and key concept art.	Complete storyboard work with VP Director and submit to design team in order to be used for set and on set provide camera plan.	Get production designer set to assist with construction standards and design.	Start working with Props & VFX teams to explore and refine ideas.	Acting Casting & Rehearsal	Acting Casting & Rehearsal	Acting Casting & Rehearsal	Acting Casting & Rehearsal	Acting Casting & Rehearsal	Acting Casting & Rehearsal	Acting Casting & Rehearsal	Acting Casting & Rehearsal	Acting Casting & Rehearsal	Acting Casting & Rehearsal
PRODUCTION DESIGNER	Start Date	Start Date	Start Date	Start Date	Start Date	Start Date	Start Date	Start Date	Start Date	Start Date	Start Date	Start Date	Start Date	
Director of Photography	Start Date	Start Date	Start Date	Start Date	Start Date	Start Date	Start Date	Start Date	Start Date	Start Date	Start Date	Start Date	Start Date	
SFX & Make-Up	Start Date	Start Date	Start Date	Start Date	Start Date	Start Date	Start Date	Start Date	Start Date	Start Date	Start Date	Start Date	Start Date	

Week Ending	DEVELOPMENT							PRODUCTION				POST PRODUCTION	
	6/15/20	6/22/20	6/29/20	7/6/20	7/13/20	7/20/20	7/27/20	8/3/20	8/10/20	8/17/20	8/24/20	8/31/20	9/7/20
ICVH Story Visualization	Start Date	Start Date	Start Date	Start Date	Start Date	Start Date	Start Date	Start Date	Start Date	Start Date	Start Date	Start Date	Start Date
STARGATE	Start Date	Start Date	Start Date	Start Date	Start Date	Start Date	Start Date	Start Date	Start Date	Start Date	Start Date	Start Date	Start Date
AR STAGE	Start Date	Start Date	Start Date	Start Date	Start Date	Start Date	Start Date	Start Date	Start Date	Start Date	Start Date	Start Date	Start Date
MALDEN Story Visualization	Start Date	Start Date	Start Date	Start Date	Start Date	Start Date	Start Date	Start Date	Start Date	Start Date	Start Date	Start Date	Start Date
LUK MACHINA	Start Date	Start Date	Start Date	Start Date	Start Date	Start Date	Start Date	Start Date	Start Date	Start Date	Start Date	Start Date	Start Date
VIRTUAL MONDERS	Start Date	Start Date	Start Date	Start Date	Start Date	Start Date	Start Date	Start Date	Start Date	Start Date	Start Date	Start Date	Start Date
DIGITAL FILM YEAR	Start Date	Start Date	Start Date	Start Date	Start Date	Start Date	Start Date	Start Date	Start Date	Start Date	Start Date	Start Date	Start Date
ICVH Storyline Dev	Start Date	Start Date	Start Date	Start Date	Start Date	Start Date	Start Date	Start Date	Start Date	Start Date	Start Date	Start Date	Start Date

PROJECT MANAGEMENT

PROJECT STRUCTURE

Objective & Test Case Design

Ripple Effect is a short-form family drama with sci-fi undertones. Through its characters, the film explores the effects war can have on the individual, family, and society.

The script, as written, would not typically be “broken down” for visual effects and/or virtual production. During our Development Phase, our Director of Virtual Production “adapted” the script for virtual production & in-camera effects defining the following guidelines:

1. Design and execute in-camera effects for smart stage LED walls showcasing:
 - a. An Interior Sequence
 - b. An Exterior Sequence
 - c. An Int/Ext Vehicle Sequence
2. Achieve final pixel in-camera effects for smart stage LED walls by:
 - a. Designing the world of the film as well as break down the script in advance of hiring Visualization Company(s)
 - b. Work with Visualization Company(s)’s Virtual Art Department (VAD) to build each virtual environment.**
 - c. Work with Visualization Company(s) to Previs key shots or scenes where timing, framing and/or emotion is important to iterate before shoot days.
 - d. Work with Visualization Company(s) to Techvis key shots and/or scenes to iterate our shot lists and shoot strategy as much as possible prior to each shoot.
 - e. We will establish an iterative in-person test schedule on location with our smart stage LED wall vendor(s) in order to anticipate and build virtual/physical tools, workflows, and resources needed prior to each shoot.

- f. Provide on-set VP/VFX supervision to:
 - i. Manage vendor workflows
 - ii. Verify quality of virtual content and identify challenges for AD (ie. frame rate, screen frequency, horizon line, correct scale, camera tracking, LED wall power issues vs. re-loading content, rotation of the virtual world, real-time asset/world adjustments, real-time lighting and color adjustments, matching practical and virtual sets, achieving parallax, and more).
 - iii. Make creative decisions in collaboration with Directors to allow for spontaneous shot iteration/changes to shots in real-time on set (to include virtual set design).
 - iv. Provide clear notes/approvals on shots captured during the shoot for the Script Supervisor to ensure the Editor had reference for best technical takes (in addition to Director's notes on best actor/camera performance).
- g. Communicate [project specific] VP in-camera effects goals with our post VFX team and provide the following guidelines:
 - i. Post VFX should be used to "fix" minor technical errors in shots (ie. smoothing screen seams, removing production equipment in shot if it cannot be cropped out by editor, adjusting exposure/color to improve shot integration).
 - ii. Post VFX can be used to create Full CG Shots of action that would not be possible to be achieved in-camera.
 - iii. Post VFX can be used to create shot enhancements that are unrelated to the content on the LED walls (ie. adding detail to character costume, adding logos to practical set pieces, adding CG prop that an actor might interact with).
 - iv. Post VFX should not be used to enhance or manipulate in-camera effects to show "what could be done practically" (ie. add reflections, replace/enhance content on LED walls, etc.)

A production can use a wide variety of virtual production tools, techniques, and workflows on a non science fiction genre project.

On Ripple Effect we chose to explore real-time workflows that would allow us to design and execute final pixel in-camera effects via real-time rendered game engines for display on smart stage LED walls.

***Typically a production would hire a Visualization Company and VFX Team to work together at the beginning of the project. The production designer, who would design/coordinate shot layout and asset builds as early in the process as possible, would provide direction for both teams as well as plan any physical set builds. With our limited schedule and limited access to committed VFX Team early in our process, we modified our workflow so that our Visualization Companies' VAD would create our final in-camera environments. Our modified plan included working with primarily pre-made, volumetrically captured assets to achieve a quality and resolution that was as photorealistic as possible within our budget and timeframe.*

Exploration of “Final Pixel”:

1. Can a Visualization Company, independently from a VFX Team, achieve photoreal “final pixel” content for display on LED walls?
2. Can real-time rendered content produce similar photoreal results as pre-rendered content as captured by the physical camera lens?
3. When does real-time rendered content appear photoreal on camera?
4. When does real-time rendered content not appear photoreal on camera?
5. Can content displayed on LED walls that does not look photoreal to one’s eye, appear photoreal in-camera? If so, how was this achieved?
6. In what scenarios would it be best to hire a Visualization Company and VFX Vendor in parallel:
 - a. When the intent is to replace in-camera LED wall green frustum with full CG environments using camera tracking metadata.
 - b. When creative/script calls for environments/assets that interact with physical talent or a unique hybrid approach that solves a specific creative challenge.
 - c. When the environment displayed on the LED wall needs to be completely in-focus or when elements in the background are the center of attention.
 - d. Designing a non-destructive asset pipeline from Visualization (Pre-Production) through Production and Post can be achieved in tandem with a VFX Company (Typical physical production team members will experience a learning curve with DAM/MAM systems).
 - e. At the present time, pre-rendered content and shot plates produce a higher quality, photoreal, “final pixel” captured in-camera from a real-time rendering game engine. Traditional VFX may help enhance this content displayed on walls. Pre-rendered quality vs real-time render quality may change in the future.
7. How does working with different smart stage vendors impact “final pixel”?
 - a. What are the pros/cons working with a smart stage vendor that provides only the venue and LED wall technology?
 - b. What are the pros/cons working with a smart stage vendor that provides a full service team to assist with content final stages and managing creative content manipulation during shoot in addition to providing the venue and LED wall technology?

The short film, *Ripple Effect* has a four phase project structure to include: Development, Pre-Production, Production, and Post Production. Two workflows were formed to showcase different skill sets, collaboration styles, and vendor services.

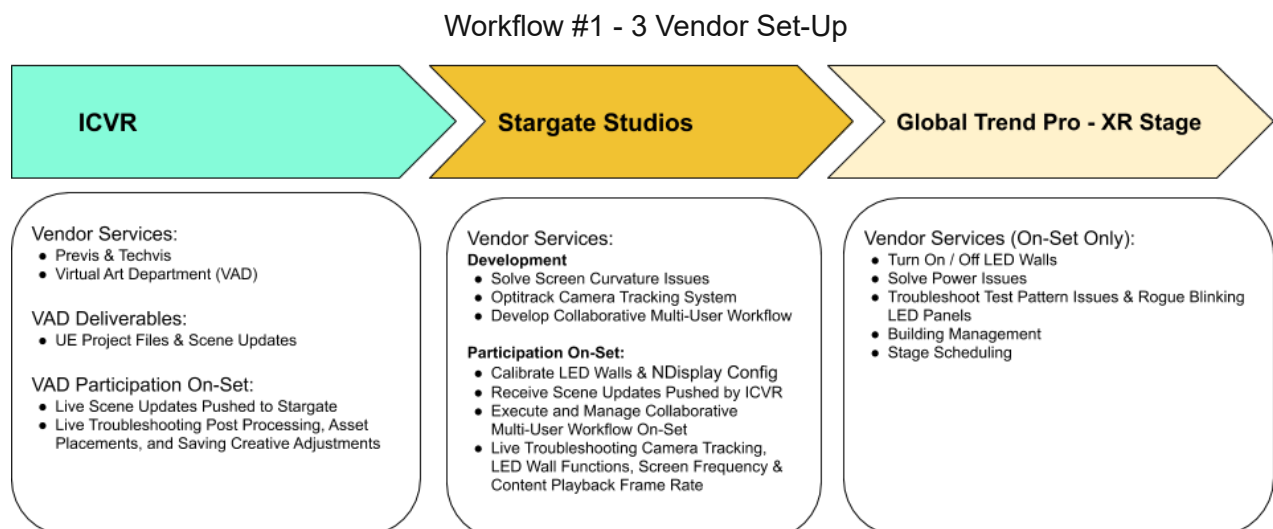

Workflow #1 - 3 Vendor Set-Up

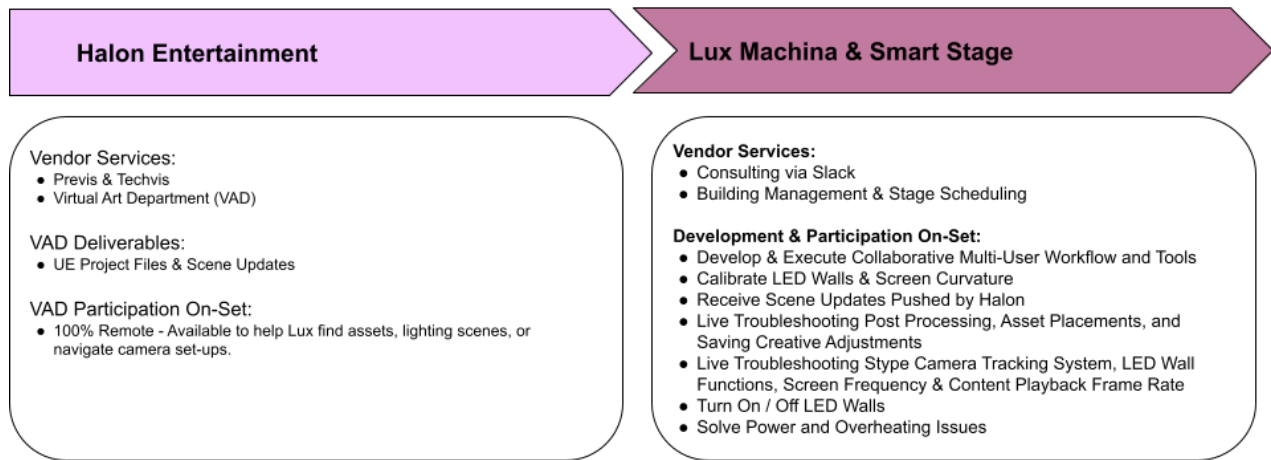

Use Cases for Final Film

VEHICLE SEQUENCE

Use Case 01: Interior Vehicle Dialogue Scene - Motion Blur & Depth of Field “Double Defocus” in the Virtual & Physical World



The interior vehicle dialogue scene was fairly straight forward to plan and execute. We worked with Stargate Studios in early stages to ensure we coordinated the proper physical production resources for a vehicle stage shoot, ie. wheel jax vs. turntable rotation of the vehicle.

We chose to design the sequence using real-time previs and techvis techniques in order to answer important questions early on in the process and remotely. The directors had many questions about where they could place cameras, how and where they move cameras in the scene, and how that would impact character performance.

The production designer, who was also guiding our VAD team, needed to visualize what elements could be seen outside the vehicle windows early in the process to understand what would be visible in each shot. For example, the directors wanted to make sure that at certain dialogue, the vehicle would pass certain landmarks, such as a factory.

Our VP Supervisor used photogrammetry techniques to capture the truck asset to be used at several points in our process.

The DP was able to access a 3D CG model of the truck on set as well as remotely from home in Epic Games', Unreal Engine 4 to visual shots for our crew and directors.

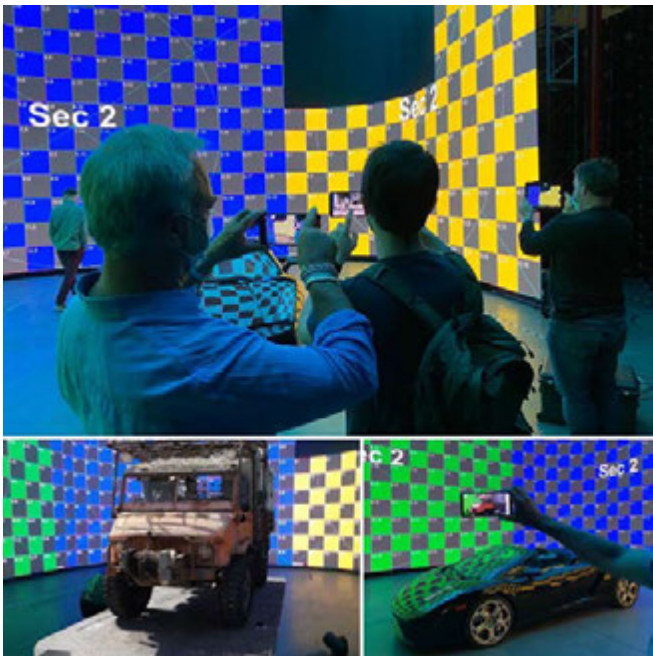

In the image to the left, the DP is using the AR feature in Sketchfab to replace a Lamborghini with our truck. The app made it possible to walk around the digital asset in our physical set to give our team and consultants an accurate understanding of the resources we would need to execute shots.

When we began our physical testing phase on set, with content playing in the background, we needed to create tools to help ensure we could profile our devices properly, calibrate the system, and check our visual integrity. Some of these tools were created by ICVR on set ie. virtual color chart, virtual horizon line checker, virtual cube assets to check scale. Our VP Supervisor and Director also fabricated physical tools such as a physical crate on a stand to check horizon line, physical color chart, placing organic objects such as grass in front of the screen to check camera focus and visual

integrity (also to see if objects lit in the virtual world matched objects lit in the physical world).

Motion Blur - Although we were able to previsualize our content with motion blur, this post process effect was disabled by the nDisplay plugin that translated our content from game engine to screen. This meant we had to run our content without motion blur, causing objects in the scene to have a staccato look as they passed the lens. During test days on set and up to final shot execution, the VP Supervisor and Director had to remove foreground elements that looked too sharp. One way we were able to address this issue was by de-focusing the content on the screen by adding a “blur” post processing effect.

Double De-Focus - This term describes the application of additional “blur” post processing on a virtual background than what may technically be needed to achieve accurate depth of field as determined by the DP. It describes any additional blur or de-focusing of the virtual background as it relates to the natural depth of field applied by the physical lens.

On set, the physical camera and lens system should set the standard for what the correct depth of field should be. Once the DP has determined this measurement using their physical camera, the virtual background should be dialed in mathematically to match. In a post VFX workflow, the compositor would receive information from the camera department in order to make sure that the virtual lens, when applied to the shots, would accurately portray focus choices and depth of field. On *Ripple Effect*, we were making these decisions in pre-production and while we executed shots on set.

Because we did not have the ability to use motion blur on the moving content playing on our LED wall, we worked with our DP to apply additional de-focus to the background that may not be technically accurate, but would sell to the viewer’s eye. This was a very effective technique overall, however, we found that it had to be adjusted considerably per shot to “look accurate.” From a data management perspective, as long as these changes can be recorded and saved per shot inside the game engine, it should not cause issues in post. Increasing the de-focus of the background can cause a visual “uncanny valley” that can affect the overall believability as well as the appearance of scale within a shot. De-focusing the background looked best when the content was designed with depth and varying tonality. If the content lacked horizon line or depth, adding blur would look like a mistake and translated as significantly less photoreal.

Use Case 02: *Virtual Content Visible Through Glass & Without Barrier in a Single Shot*



At first glance, this shot composition seems simple, however it has its own unique challenges. It is very hard to sell photoreal visual effects at a direct, head-on angle like this in general. The content we created for our virtual backgrounds was not photoreal to the eye and this made it more challenging to sell to the viewer.

Adding additional “blur” or de-focus to the background helped our team “sell” the background as photoreal. Please note that the image to the left is not color corrected. In post, the colorist was able to pull more yellow and neutral tones back into the image. The colorist was also able to isolate the truck window enhancing the natural reflections captured in-camera.

Once our vehicle was in place, our team rotated the virtual background in real-time to adjust the perspective of the road behind the vehicle. We used both virtual and physical tools to check horizon line, color, and object scale. The image to the right shows our VP Supervisor evaluating the horizon line before we rolled a take.

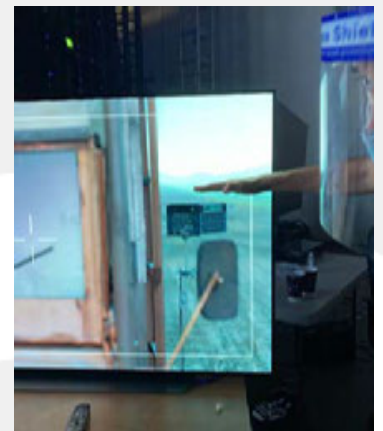

Use Case 03: *Vehicle Scene that Combines Interior & Exterior of Vehicle, Shows Movement Away from Screen, and Wind SPFX*



The images above are from one continuous shot. Similar to Use Case 02, we wanted to show the truck moving away from the LED wall. However, in this case study we added camera movement that moved up and panned right to follow the character's action back into the vehicle.

Considering the speed of the vehicle and the character's position outside the vehicle window, we used practical wind special effects to enhance the reality of the scene. Our production designer tied a red ribbon to the outside of the truck to help connect the wind from the beginning to end of the shot.

When shooting against LED walls, it is important to focus on foreground and practical subject matter. The red ribbon in the midground was a useful tactic to persuade the viewer's eye to focus on the talent in the car at the opening of the shot. Creating realistic physical movement of the truck was also important. It took two individuals on either side of the truck to create a "jostling" motion as if the truck were on a bumpy road. Ideally, the truck would be on a turntable or motion controlled device that could respond in real-time to the "bumpiness" of the virtual scene. We did not have access to this technology and had to create this illusion by hand.

When shooting a low angle it is important to note the top edge of the screen. It was critical to have our VP Supervisor, VP Director, and Post VFX Supervisor watching our takes on monitor to make these corrections in-camera on set.

Use Case 04: *Vehicle Driving Forward to Show Movement Toward the Screen*

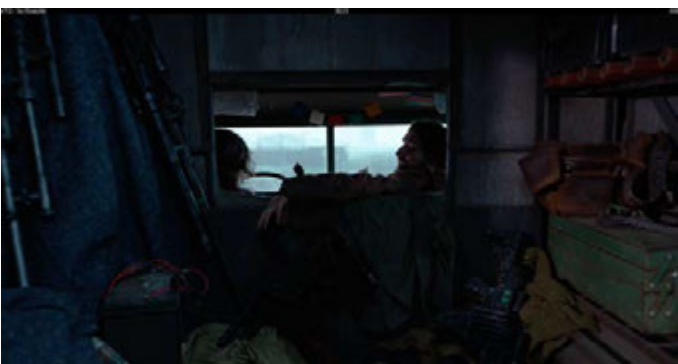

This is an ideal shot composition for using virtual backgrounds displayed on Led walls. It is one continuous shot that travels from the back of the truck through the vehicle to the front cab. As the camera moves toward the front cab, Gary pulls a metal detector from the back of the truck. The metal detector crosses the windshield as he places it in his lap.

This would be a challenging shot to rotoscope in post and demonstrates an advantage for planning to capture VFX in-camera on an LED wall in advance. A greenscreen may cause unwanted light spill that needs to be removed. By committing to this workflow, we were able to avoid green spill removal, 3D camera tracking, roto, and compositing steps in post.

INTERIOR SEQUENCE

Use Case 05: Interior Scene with Reflections Captured In-Camera & Use of High Contrast Content without Tech Issues



The dining room set was designed to include one large window to fill the majority of a single wall. Although we had originally planned to use glass as the window material, we had to modify this choice (to plexiglass) in order to stay within budget. Both materials react to light differently and require unique planning. Glass is more predictable. The quality of its surface is even and is set in a rigid, flat shape. Due to this, it is less likely to magnify light and objects behind it. Plexiglass tends to warp subject matter and light and the results will appear different in the center of the material vs. its edges. (See Case Study 07)

Case Study 05 includes both a static nodal shot and a slight horizontal dolly movement.

Reflections - We were able to capture reflections in both the moving and nodal shots. Our DP was able to light the set independently from the wall, which created depth and the flexibility to flag lighting that might illuminate our camera crew who moved behind the talent. As is typical when working with reflections, controlling what you see and do not see is very important. It was a requirement on set that any crew within proximity of talent would wear two levels of PPE, a face covering and a face shield. The face shields were plastic and reflective – sometimes causing unwanted reflections in the window that we identified and removed in-camera.

To ensure we had the proper amount of space on set, techvis helped our production designer and DP visualize the depth they would need to accommodate early on. Avoiding moiré was a top goal of ours.

To minimize moiré, we planned to have our plexiglass window no less than 15ft from the LED wall. With a glass window, we may have only needed to place the window 10ft from the LED wall. From here, we worked with our directors, DP, and production designer to block out the shots in the dining room scenes using an Unreal Engine, multi-user, remote workflow. The creative team could figure out the best way to tell the story in real-time. The VP supervisor and VP director also participated in these sessions remotely, available to make recommendations based on technical requirements needed on the day of the shoot or other logistical considerations. The VP team worked with the production designer and DP to imagine ways to integrate the LED wall content creatively into each shot and how to achieve the strongest composition – foreground, mid-ground, background.

High Contrast Content - There are a few technical factors to consider when designing low vs. high contrast content for display on LED walls. The hardware that is running the content as well as certain technical choices will affect the success of either option. Screen frequency, frame rate, genlock, bit depth, and pixel refresh rates are the first few to consider.

High contrast, darker content tends to reveal more artifacting. Taking time to profile devices and calibrate your hardware systems can help you reduce, isolate, and remove artifacting. These considerations need to be made when planning to allow time during physical testing to remove any unwanted artifacting. These are not challenges that you will want to work through on the day of your shoot, it can be very time consuming.

In the dining room sequence, we experienced visible scan lines and banding that spanned the entire LED wall. At XR Stage, we did not have the option to genlock our LED wall and camera system. This made completely removing scan lines and banding impossible. We manipulated wall frequency, camera frame rate, and shutter angle to remove them as much as possible. In shots where the artifacting remained visible, we often had to adjust the camera angle or time the character's action between scan line movements. We did not experience this issue at Lux Machina's stage as we had the ability to genlock our hardware systems. (Continued in Case Study 06)

Use Case 06: Shooting 60Hz LED Wall Through Plexiglass at High Frame Rate with High Contrast Content

At XR Stage, we had the ability to set our LED wall to different frequencies. Per early screen frequency / frame rate testing with a Red Monstro camera and stock content (for the LED wall) provided by XR Stage and Stargate Studios, our DIT, Dane Brehm provided the following observations:

“...at 23.98/180 deg (1/48th) we see a distinct flickering, mostly in the top portion LED ceiling that meets the edge of the corners. Capture wise, 23.976fps isn't an issue but may be limited to 60Hz windows for our normal and offspeed capture. Shutter examples @ 23.976fps are 144, 216, 288 deg shutter to keep us within a 1/60th window. Acceptable 60Hz frame rates would be 6fps, 23.976, 29.97, 47.95, 71.98, and 95.97.”

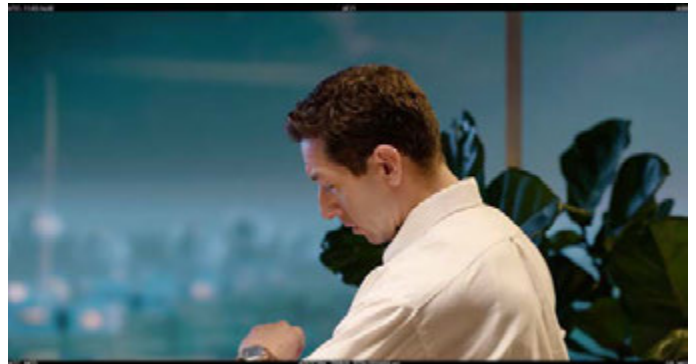

We chose to shoot both the Truck and Dining Room sequences with a screen frequency of 60Hz. For Use Case 06, our directors storyboarded several high speed insert shots to portray a tense family conversation that would take place at the dining room table. As depicted in the image above, Ara is late for dinner and her father is checking his watch. Our DP chose to shoot these inserts at 60Hz screen frequency/ 48fps/288 deg shutter. Per our DP:

“The Directors wanted some slow motion shots at the highest frame rate possible. With an ARRI LF shooting Open Gate this is technically 90fps. We were able to capture 48fps at a shutter angle of 288. But at any faster setting we would see flickering.”

We were able to capture each take without artifacting. The distance of the camera to the subject, the plexiglass window, and the LED wall were far enough apart that moiré did not need to be addressed in these shots. To further reduce complexity, this was executed as a static, nodal shot.

Use Case 07: Shooting 60Hz LED Wall Through Plexiglass with Steadicam Movement - Avoiding Scanlines, Banding, & Moiré



Use Case 07 presented the widest variety of challenges regarding artifacting and moiré.

The images above represent one continuous camera movement. The camera slowly pushes in toward Ara. As we approach her, we are focused on her profile while pulling back and rotating our view to the right revealing her family at the table. As her father begins to speak, the camera moves forward toward them and lowers slightly to match the height of those seated at the table. The camera follows the conversation between mother and youngest daughter and ends framing a wide shot behind the father revealing the family together as whole.

Our LED wall is featured throughout the entire duration of this shot at varying heights, movements, speeds, and angles.

The directors felt it was important for the camera's movement to reflect the intensity of the conversation and embody a shift in perspective. They decided to use steadicam to translate their vision. This choice added complexity to the shot because the camera had more freedom to move on a z-axis, making the distance of the camera to the screen (and plexiglass) a new variable.

Because the steadicam took up less space than the dolly, it also allowed us to capture wider framed shots of the dining table. However, this also meant that the camera's angle to the LED wall (and plexiglass window) was narrower at the edges of the room on either side, causing moiré that was not visible at a similar angle with our dolly. The plexiglass material of the window exaggerated and magnified the LED wall, especially at the window's edges or surface areas that were slightly warped.

Without a material such as plexiglass in front of an LED wall, a general rule for avoiding moiré is that the lens should be perpendicular to the LED wall. If shots with camera movement are planned, using a curved screen is helpful because as the camera pans and moves it simplifies the operator's ability to keep the camera as perpendicular to the screen as possible. For a nodal pan shot, depending on the calculated curvature of the screen, from its center one might have room to pan left or right within a 120 degree section of the screen avoiding moiré. A curved LED wall also ensures proper reflections on talent as they move across the stage.

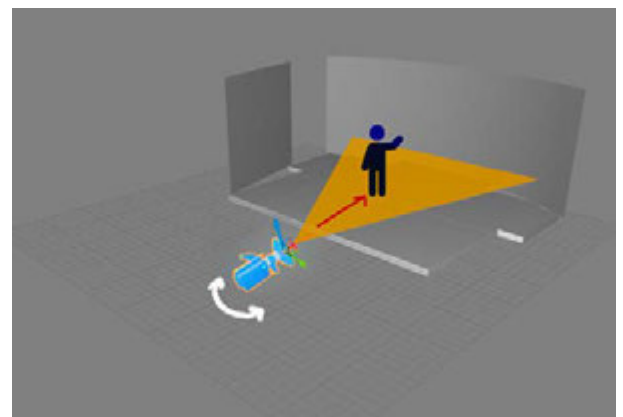

The majority of our dining room scenes were shot nodally or with controlled movement on a dolly. With

these tools we were able to frame out moiré, adjust focus away from the window, and shoot dialogue in shorter takes to avoid scan line visibility in darker, higher contrast areas outside the window.

To achieve this shot, it took a lot of patience and choreography between our camera operator, directors, and VP supervisor. This shot required multiple takes to reduce errors in-camera with department heads keeping a close eye on the monitor. Training each department head's eye, as well as our directors, to visually recognize moiré and scan lines was challenging. However, once everyone could see the errors, it made it easier to work as a team to make the adjustments needed.

Use Case 08: Interior/Exterior Combined Scene with Reflections & Low Contrast Content on LED Wall



Shot A

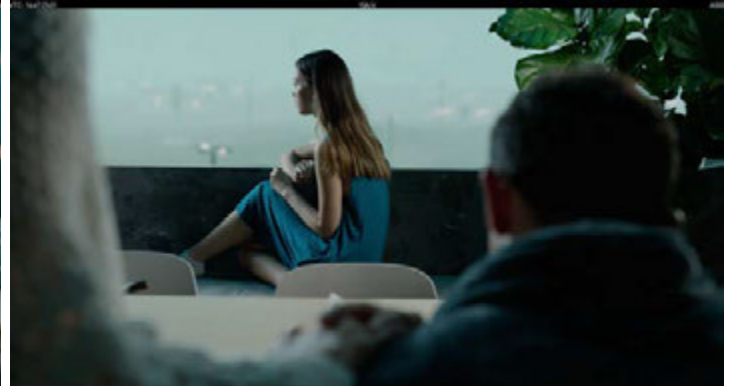

Shot B

The images above represent two different shots within the same scene. Ara has gone missing and her younger sister sits by the window as her parents call in the report. Shot A shows reflections of the world successfully captured in camera from outside the dining room window. We did not experience reflected moiré or artifacting. In Shot B, our expectation/theory was that scan lines and banding would not be visible as the content was lighter in tone and much lower contrast than previous scenes. Although the content was low contrast, the scan lines and banding were less noticeable, but still visible. To effectively remove scan lines and banding that span across the length of the entire LED wall, all hardware systems should be genlocked to a single master clock.

EXTERIOR SEQUENCE

Use Case 09: Practical & Virtual Set Integration – Without Using Color Correction in Engine (All additional integration in Color/Post), Use of Physical Foreground Elements (Use Case 09 did not make it into the Final Edit)



As originally written, *Ripple Effect* was structured as three intercut sequences that visually progressed through the film's narrative. In post production, the directors re-engineered the story to include and be driven by the character of the younger sister's voice over. The main difference was the shift in point of view. In pre-production and production, all of our shots were designed based on an approved script from a point of view that would naturally shift based on the character relationships in each scene. In post, when the voice over was added, the entire story was told from the younger sister's perspective.

Use Case 09 was removed from our final edit as it no longer served the story.

From a virtual production perspective, Use Case 09 was a high value success both in execution and learning. Designing practical and virtual sets that integrate seamlessly is a complex process. In our brief development phase, the director of virtual production worked with the directors and their world building mentor to discuss and evaluate the complexity of each sequence, especially the Battlefield. There were several conversations early on about how to achieve the director's creative vision and also reduce its complexity so that we could achieve the best results on set.

Visual examples of successfully integrated virtual productions using similar workflows, integrating LED wall and physical sets for final in-camera effects, were provided. We specifically referenced Epic Games and Lux Machina's 2019 Siggraph demonstration, which showcases a rocky, vegetation-less environment with a basic gravel practical set extension. This was used as an example of the type of environment that could likely be produced with very high photorealistic results on our project timeline. We showed examples from *The Mandalorian* in reference to the wider variety of landscapes that could be designed and discussed complexity on a shot by shot basis. It was important to set expectations in regard to the quality of *The Mandalorian* as their team consisted of a committed VFX team and a much longer development period for the show. The wide variety of sets that they created were useful visual examples to discuss shot design with our directors, highlighting the importance of creating depth using background, midground, and foreground in their virtual and physical shot compositions. It was important for the directors, VP Supervisor, DP and Production Designer to communicate and iterate ideas early on and throughout the process. We referenced content such as West World S03, specifically to show how LED wall content could play nicely outside vehicle windows and to illustrate how focusing on practical elements in the foreground of a shot is an important methodology for integrating the foreground and background in camera through depth of field.

Vegetation adds complexity to an environment designed for LED walls for several reasons.

- Vegetation on LED walls requires more asset optimization to run properly in a game engine.
- Vegetation is highly detailed and is harder to stitch between LED walls. If the camera moves or changes framing during a shot you will need testing time on the stage to make sure the practical and virtual sets are designed to integrate if those changes occur on set. Otherwise, the virtual and practical sets may not match and could cause issues on set or visible imperfections.
- Vegetation is easier to sell to the viewer's eye when there is slight movement, however, the movement has the potential to create stitching issues on set as well as optimization issues.
- Staging vegetation in front of LED walls can cause edge issues where the emitted light from the screen and practical light meet. If grasses and vegetation are part of the design, they should be staged further away from the LED wall. Hard surface objects like rocks are recommended for best results and can be staged closer to the LED walls.
- Using moss, lichen, and sturdy vegetation can help reduce complexity.

Creative Challenge - “Vegetation Example”

The directors wanted to include vegetation in the design of the environment because it’s essential to the story. What are the design considerations using tall grasses and lush plants with leaves?

In a general sense regarding how vines/grass/leaves translate to the LED wall, if well matched to on-set props and particularly in the case of grasses, the Halon VAD team noted that these can help hide a seam between the LED wall and the floor, and can be designed in a way that falls off from practical to CG. See *Mandalorian* S01:E04 Sanctuary for reference.

This does not come without its challenges. In addition to the challenge of matching organic elements, any foliage that would easily react to a slight breeze would either need an on-set breeze in order to match or would need to be static. Static grass may feel unsettling to the eye when our brains are conditioned for ambient movement. On-set breeze can be used, but given the time and resources for this project, it wasn’t certain if it was a wise challenge to shoulder if there was a usable alternative. Using moss and lichen, more sturdy vegetation, seems like an appropriate way to get around those issues.

As far as run-time lag due to moving vegetation, there aren’t any hard specs on how it will impact run-time on the wall as many factors go into determining that such as the density of the plant-life, it’s fall-off distance from the screen, and the meshes used. For example, an unbroken field of tall grass would command more energy than small patches of tall grass popping up here and there.

Referencing the concept image from the look book, it helps that the landscape will be broken up by metal structures and mounds of bodies but looks as though the ground grass is pretty consistent throughout. If the grass is still desired, it’s suggested to remain fairly short (not quite lawn short, but short enough to not be as wind-reactive) or be present in patches. This is a humid environment where the vegetation grows quickly, so perhaps some rich soil as the main ground layer and tall thick-bladed grass (less reactive) where the bodies have landed (the corpses are feeding the ground?) works as a concept. That combined with a larger footprint of moss and lichen may provide a nice balance for optimization, and having grass present in patches allows the staging of practical organic elements further away from CG ones.

Lux Machina Stage Operation: The movement of objects, such as grass or leaves, in an environment can cause stitching issues between LED panels due to slight latency. The art direction of elements in a virtual environment will/can affect latency of object movement between panels. These are typically challenging and custom solutions.

If you incorporate natural/organic elements, they may need to be a minimum distance from the LED walls to avoid edge issues. Rocks and/or hard surface objects are recommended in general and integrate with a higher success rate.

VP Supervisor & Director: Our goal is to make sure the highest quality images are captured in camera including overall shot design. We want to make sure the designs are intentional and serve the story. We also need to make sure we have the right resources and preparation in place to achieve our goals. After reading our approved script, our VP supervisor also helped guide conversations like these with our directors:

Often the visual language of nature growing over objects illustrates history or that there has been a long passage of time. There is a note in the lookbook that plant life grows quickly and also that the Battlefield that we see has been newly fought on. As the viewer will never see how fast the vegetation grows in this

environment and the characters arrive at the Battlefield after the world is overgrown, does the visual cue of dense vegetation still serve the story?

Technical Considerations Examples: How will these creative choices impact optimization and game engine performance on set? How much flexibility do we need on set to manipulate the design of the virtual environment to solve problems quickly and efficiently? How is our VAD team approaching lighting in our environment - will their process translate properly to the tools we need for our DP on set? How do we ensure our directors are accurately viewing creative during the visualization process and have an understanding for what the world will look like on set? How do we approach color management for in-camera effects and camera dept on set? How do we ensure our virtual set is aligned with the design of our practical set - is there a virtual tool that I can use on set to visually verify this? How do we measure the horizon line on set? What infrastructure do I have access to for reviewing creative from our VAD teams? Are we ensuring that all assets are in proper real world scale? (These only represent a small slice of the technical considerations as an example!)

Producer: Our goal is to make sure the majority of our budget and resources appear on screen. We need to accomplish our best work on time and within budget. On this project, we are committed to achieving final pixel in-camera effects displayed on smart stage LED walls. What are the most effective creative choices we can make to tell our story, push the technology, and develop a procedure for achieving our goals?

Technical consideration examples: In what areas do we have to make rigid decisions and in what areas can we afford to make flexible decisions? How much time will our production designer need to build and test their virtual and practical designs on stage? How much does stage rental cost? What can we design remotely vs. in person physically during our visualization process? What creative decisions can only be made in person, on set? What is the most effective review process for our team? What is our creative approval process and how are the approvals communicated downstream? How/when do we schedule photogrammetry shoots of our practical sets if there are delays in design approval and cash flow for set builds? How will including rapid photogrammetry and data processing on set impact our workflow and schedule on set? Who do we need to have on set to ensure the best technical results are achieved on the day of the shoot?

Use Case 09 was designed to be a big reveal of the Battlefield landscape. The shot begins, framed on Gary's metal detector and slowly widens in framing to reveal both Pip and Gary, full body, in the Battlefield. In the final framing, the physical foreground elements are visible, the seam line of practical and virtual set is visible, and the real-time content is fully visible.

The following expectations were established early on with our directors:

1. Choosing to pursue the creative direction in Lookbook v4 may reduce the overall final quality you are able to achieve in our current timeline.
2. Choosing to design the creative to the strengths of the tech by starting with a desert landscape that has accents of natural elements may give you a higher quality end result on the LED walls.

Additional Learnings:

During our visualization process, we determined that we would be able to frame full body wide shots without relying on set extensions added in post.

We were not able to run tests with our content along with final physical set design until the week of our shoot. We had three days to test before our 1 day shoot. During test days, the practical set was being constructed and we had very limited time to dial in color and composition for the mid-ground of the shot where the LED wall and practical stage met.

A major concern for our production designer was whether rotating the virtual world would impact the design of the practical set. Our practical sets were not designed to fly away in sections or move, they were static. Each scene had a different practical set layout. They were not designed to rotate along with the virtual world. This is an important consideration to make early on when designing layouts, actor blocking, and camera shot lists. During our test days on Lux Machina stage, our production designer focused on building out 2-3 feet of set that would be closest to the LED wall so that we could prioritize these challenges first on test days. A background in theatrical set design will come in handy for a production designer working in virtual production.

Wide expansive shots as depicted in Use Case 09, require photorealistic in-camera effects to read well both to the human eye and the camera.

Use Case 09 would have been ideal for greenscreen frustum use to replace our visualization quality VAD environments with photoreal visual effects environments in post. On *Ripple Effect*, we did not have a dedicated VFX vendor committed to our project early in our workflow. In June/July there were massive layoffs in the VFX community which increased uncertainty about committing donated resources to a volunteer based project. Post VFX teams were open to negotiating on a shot-by-shot basis and not able to make an open ended commitment. The limited visual direction from our creative team, impacted what we could ask for. By August, we were able to secure commitment for post VFX with help from Brook Noska and FuseFX.

For wide expansive shots of an environment, it is ideal for the production designer to provide both the VAD and VFX teams with designs and work with both vendors to sync creative vision and build shareable assets. Uniting the creative vision for both VAD and VFX will help ensure the VAD team is providing proper reflections, reference, and lighting on set that can be replaced with matching final imagery behind talent in post by the VFX team.

It is important to design the virtual world so that it stops at the plane of the LED wall.

To the right is an image produced by our VP supervisor showing what happens when virtual content is designed to exist in the z-axis beyond the plane of the LED wall.

If the virtual world stops at the plane of the LED wall, the virtual assets that are the closest to the camera on z-axis should be the correct scale and their tracking to camera and parallax should appear correct.

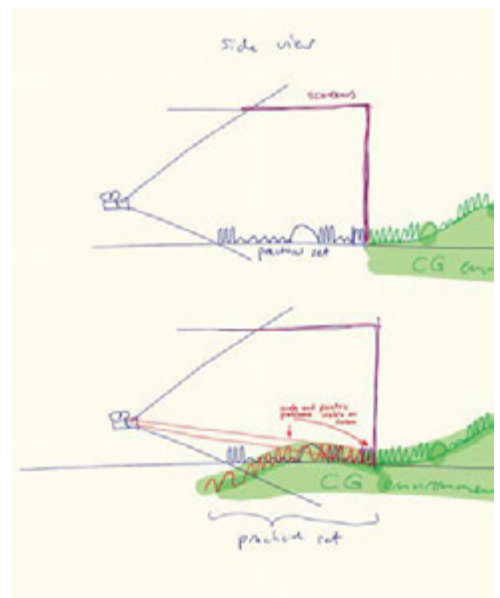

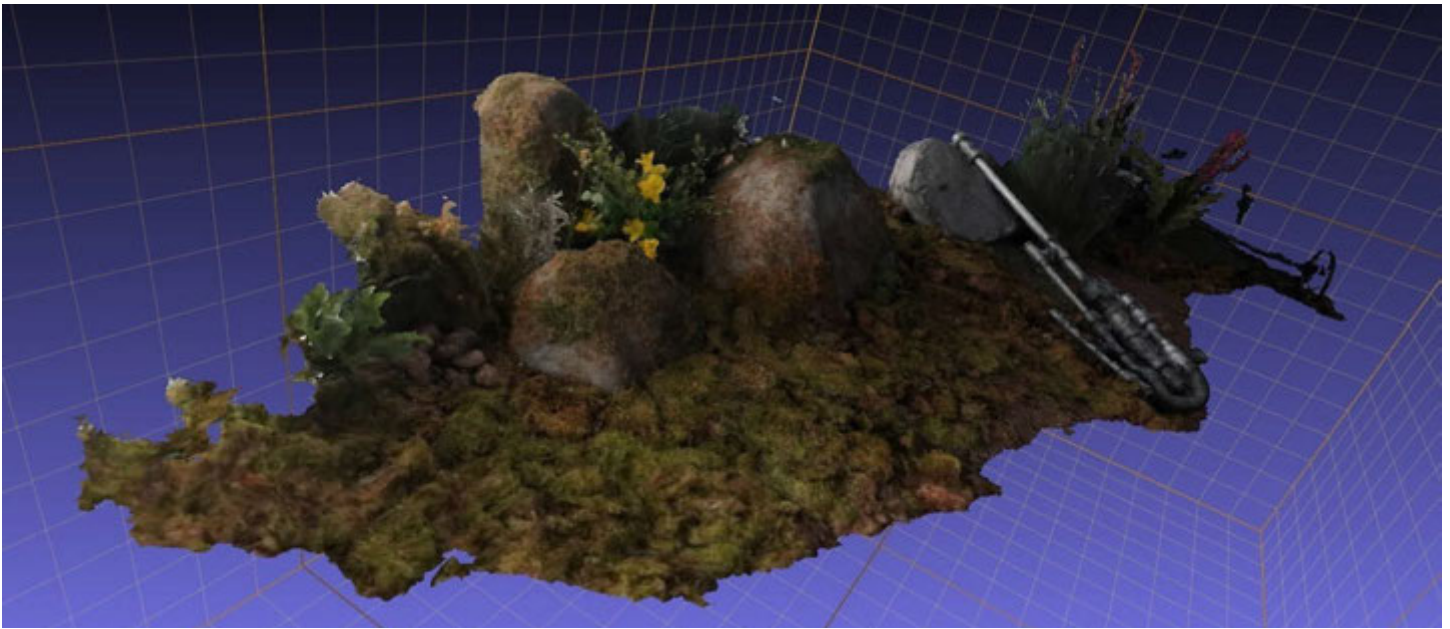

If the virtual world surpasses the plane of the LED wall, any virtual assets that exist beyond the plane closer to the camera will be compressed in space. They will appear to be the closest objects to one's eye, however in 3D space, they may exist "on stage." By compressing the virtual world to the plane of the LED wall, any assets in the foreground will have incorrect scale. If the camera moves, their tracking to camera and movement of parallax will move at the incorrect rate. In horizontal camera movements, this may appear to be a tracking stutter or slipping movement of assets. If the camera moves vertically, it may look like your virtual environment is slipping and stretching underneath the practical set.

The image above shows the use of photogrammetry as a technique we used to dial in physical and virtual set integration. Our VP supervisor was able to rapidly capture our set and produce 3D assets for our stage operators to add photorealistic elements from our physical set into our virtual world. We were also able to use digitized physical assets to improve set alignments. These assets were also available for our post VFX team.

Use Case 10: *Practical & Virtual Set Integration – Using Color Correction Along Content Seam in Engine, Use of Physical Foreground Elements*



Use Case 10 was designed to showcase extremely close foreground grass elements on our practical set to enhance the illusion of depth in our short stage area. It guides the viewer's attention to the practical set and physical action, normalizing the softness of the virtual background.

The ability to color correct live on set also helped tie the foreground and background together. Although we spent several hours visualizing this shot and sequence, our physical testing days with content on the screen were also used to further iterate our virtual production design.

The image below shows an early version of the Battlefield that included vibrant blue flowers. Once content was presented on the LED walls, the directors decided to omit these as they could not be replicated on the physical set. It also reveals an issue with our lighting set up in the virtual scene.



The lighting setup within the virtual scene was constructed using compositing techniques to improve optimization in the scene and achieve the specific creative requests from the directors. In this photo, one can see that the sky is bright red, but it is still not quite right in the CG environment.

On set, our DP wanted the ability to adjust the color of the sky and intensity of the lighting in the virtual world to match his on-set practical lighting. He wanted to reduce the amount of magenta in the scene. Additionally, when the DP matched the virtual lighting set up on our practical stage, the physical asset surfaces reacted correctly to his lighting source and it made it very noticeable that the virtual world's lighting was constructed differently. We needed to understand what the virtual lighting set up was so that the DP could match and integrate both worlds.

When the VP supervisor and smart stage operators deconstructed the scene on set, we learned that the sky was built using an HDRI as its base with card layers overlaid to achieve the exact creative look that the directors requested.

This impacted our flexibility to adjust lighting in real-time on set because we did not have a virtual source light or global lighting structure to manipulate in Unreal Engine on set per our DP's request. It impacted how the assets' surfaces responded to the lighting set-up, which meant that when we "normalized" the

lighting by deconstructing the sky box, it flattened the color in the entire world. The image below is an example of what our scene looked like when we removed the HDRI.

We had two main choices:

1. Ask our stage operators to re-create our lighting in Unreal Engine so that we had an interactive source light and fill lights.
2. Revert back to the provided sky box with our understanding of its construction and live color correct our environment to integrate with our practical set and lighting.



Choice 1 would have taken several hours to achieve on stage and we did not have that time budgeted. We decided to proceed with Choice 2.

The Lux Machina team was able to restore the skybox to its original construction in a short amount of time. They had the ability to color grade the midground of the virtual background to match the lush green center seam line of the practical set. Adding the extra bit of bright green grass in the foreground helped tie together the landscape and color scheme in our final shot.

Deconstructing the skybox on set was imperative for the DP to fully understand how to engineer the proper lighting set-up on set. Having a client side CG supervisor present as well as the vendor's VAD lead could eliminate such issues on future sets. The CG supervisor could help ensure that both vendors' lighting set-ups are constructed in a harmonious fashion and guide the stage operator through fixes instead of relying on stage operators to fix all last minute issues on set.

Halon Entertainment was working remotely on our project and was not able to actively make changes during the shoot. They provided top level support with the deconstruction process, helping verbally guide the stage operators through the process. In the future, if a VAD vendor is working 100% remotely, it would be ideal for them to be able to collaborate with the stage operator in a multi-user session to play an equal role troubleshooting on set. A strong network connection would be imperative for this.

The image to the right shows another perspective of our team working through the same lighting issue.

The DP was setting up Scene 07 which needed to match Scene 05 lighting and color. Scene 05 is cued up on the laptop in the foreground of this image. Directly behind is a view from our camera feed showing the mismatch between our virtual and practical set. In the background, our set is visible showing the amount of magenta remaining in the environment.



A CG supervisor could help avoid these issues early on by communicating best practices with each vendor and helping to review work along the way.

Below is a photo showing the midpoint in our deconstruction process where we removed the red sky card and galaxy card textures to reveal the HDRI. As seen in the photo, the directors and production designer are having a creative meeting about next steps. Our VP supervisor and DP analyzed a virtual color chart on

the LED wall and a physical color chart in front of the wall at each step of the process to better understand each lighting set-up.



Moiré - Use Case 10 had to be especially choreographed to avoid moiré. The closest focal plane distance to the stage that we could sharply focus was 9ft from the LED wall plane. This meant we could not start the shot with our actor in focus because their action started much closer to the wall than 9ft away. To extend the beginning of the shot, the directors chose to start the viewer's focus on the foreground grass and slowly rack to Pip as she hits her 9ft mark. From this point on, the camera could safely focus on Pip's action in the scene without seeing moiré on the LED wall.

Use Case 11: *Vertical Camera Movement Across 24Hz LED wall & Use Multiple Depth of Field within Single Shot*



Images above represent a single shot that covers one camera movement. The first $\frac{3}{4}$ of the shot was used in the final film.

In Use Case 11, Gary enters frame left, travels toward the camera, and pauses in a medium close-up before walking directly past the camera. Our camera starts in a high vertical position and travels down to

meet Gary in his close up. The movement reveals realistic parallax in the virtual background environment. The perspective is able to change in real-time based on the position of the physical camera, which is a unique characteristic of an in-camera effects workflow.

The shot is also designed to avoid moiré by adjusting the depth of field throughout the shot. As Gary enters frame, he is out of focus. His position is too close to the LED wall at this position and moiré would be visible if the camera were to focus on him. Instead the camera was set to our 9ft minimum distance away from the LED wall. As soon as Gary comes into focus, he remains in focus as he approaches the camera, which progressively softens the detail in the background of the shot as he moves forward.

The illusion of depth in this shot was also enhanced by the production designer's decision to have this vantage point look like there is a cliff fall off or valley below in the distance. The depth in landscape combined with the camera's vertical movement downward played well together by intensifying its dynamic energy.

At Lux Machina, we were able to genlock our hardware systems and this prevented a majority of the artifacting issues we experienced at XR Stage, such as scan lines and banding, where we did not have a genlocked configuration. For the Battlefield sequence, Lux Machina's stage was set to 24Hz and our camera frame rate was 23.98/180 shutter.

At this frame rate and screen frequency, certain horizontal and vertical camera movements would create what looked like tearing and/or a slight stutter. Genlocking our hardware systems ensured that even if certain artifacting that was visible to the eye appeared on the LED wall, we would not see this in our final images. On set, we flagged several takes for Use Case 11 as having a slight tearing artifact during vertical movement in the shot. During playback, the tearing was not visible, however for insurance, we also captured a static alternative for this shot on set, just in case. Use Case 12 is alternative coverage designed as a potential replacement while on set to make sure we had the coverage needed to tell our story. We were not able to verify that the artifacting was removed while on set and had to verify this in post.



With limited time on set, we were not able to fully dial in the practical lighting along our practical set seam. The images above are taken from the raw footage and show the dark, almost black grass along the physical set edge.

Use Case 12: *Horizontal Camera Movement Across 24Hz LED Wall with Foreground Element (Use Case 12 did not make it into the Final Edit)*



The images above represent two intercut shots. The shot of the top of the speaker pole is a separate insert shot that is cut into one continuous horizontal dolly movement and pan following Gary's character.

Use Case 12 is alternative coverage designed as a potential replacement for Use Case 11 while on set in order to work around slight visible artifacting. To avoid the slight tearing/stuttering that occurred in vertical movement across the screen, the directors designed a horizontal dolly movement incorporating foreground elements to reach the same story beat.

After vetting Use Case 11 thoroughly in post, it was approved for use in the final film and replaced Use Case 12.

The methodical movement and pacing in Use Case 12 is another example for how a director can maximize a small LED wall by creating depth on the z-axis. The virtual environment was designed with a strong foreground, midground and background, giving the illusion that the horizon is much farther away from the viewer. Adding the physical speaker pole directly in front of the lens grounds the viewer in the world. The camera's movement around the speaker pole mirrors Gary's action of "taking in" the Battlefield as he listens to the voice emanating from the speaker, immersing the viewer in the intensity of the alien planet.

Simplifying the framing to a medium shot of Gary reduced the complexity for our crew who would otherwise need to match lighting and the position of set decoration along the practical and virtual set seam.

Use Case 13: *Photogrammetry Scanned Asset Included in LED Wall Content & Show Animated Asset Captured In-Camera (Anim to Demonstrate Real-Time Lighting in UE. Assets used in Virtual Scout, Previs, & Final In-Cam VFX).*

Story & Design Context -

The discovery that Ara has been turned into a cyborg was a major plot point in our approved script.

The Battlefield environment was designed to have multiple reveals. The vibrant, alien landscape represents the violence and beauty of the 'natural' world as well as the aggressive relationship between colonizer and indigenous species. This motif is integrated throughout the film and is especially relevant in the scenes that connect the truck with the Battlefield. It is woven into the relationship between the cyborg and human population on the planet as well as the ecology of the environment itself.



When Gary and Pip step out of the truck after driving several hours, we start to see how warm the lighting becomes. It has shifted from cool blue tones to a yellowish, orange-rose. The wide shots in Use Case

09 were intended to reveal the wide expanse of the Battlefield, its slightly red, jewel tone sky, and the beginning of a deeper journey into the unknown. There are large metal weapons, broken structures, and piles of bodies mutilated by war in the distance as Pip and Gary start scavenging for scraps and parts. They are overgrown with vegetation even though a battle has taken place within only a few days.



On this alien planet, the atmosphere is very humid and vegetation grows almost instantaneously. It is alive. What the viewer may interpret as overgrown greenery over a long period of time has actually happened overnight. When Pip uncovers Ara from a deep layer of vines, they are a result of the vegetation having grown quickly. The lush plants actively reclaim and recycle invading humans, aliens, and objects that trespass, turning them into a part of itself. The motif of the colonizer vs. the indigeneous culminates

in the discovery of dead cyborg Ara covered in vegetation, with her cyborg chip harvested by Pip, a local scavenger. This moment connects the complicated relationship between humans, cyborgs, and the world itself. It also connects us to another broad theme in the film that explores the effects war can have on the individual, family, and society.

Use Case 13 was not a fully realized shot during our script breakdown process. It was a discovery made by our directors over time as they worked with Halon's visualization team. During our sessions with Halon, the creative team was able to explore deeper meaning in shot placement and quickly iterate different versions of the final impactful moment. Early on in the process, our director Hanna Bang had imagined the end of the film with several truck exteriors, and extremely wide, aerial shots of the truck driving away through the alien landscape.

As we did not have an open-ended commitment from a post VFX vendor early during the pre-production phase of our project, we modified the original scope to show tighter shots of Pip and Gary returning to the vehicle and turning it on. For this specific use case, it meant that we could not plan for set extensions in post. We could not plan multiple full CG shots. Digital Domain worked with us closely throughout our pre-production process consulting and was able to commit to helping us develop and execute one full CG shot. Halon would help us design the full CG aerial shot and Digital Domain was originally slated to execute the final VFX. Later in the process, when FuseFX joined our team, they were awarded all post visual effects work on the project. They completed our full CG aerial shot, a few additional full CG shot requests, and minor paint-outs and fix-its.

With Halon's expert team and real-time visualization tools, we were able to set clear expectations with the directors as to what the widest framing of the environment would look like. Once our environment was built and the creative team could start placing cameras, the directors were able to pick two wider angles that Halon's VAD team would uprez and optimize to be as photoreal as possible within our time frame. From here, we were able to block cameras and action, locking frame choices. We were also able to design one full CG shot that could be accomplished within our schedule and resources.

This process was the gateway for our directors, DP, and VP team to design the final composition for Use Case 13. It was important to visually connect Ara with the expansive landscape and the moment when Pip and Gary drive away. The shot is composed with cyborg Ara, sitting upright, dead in the foreground as the truck slowly drives away leaving her to become part of the landscape along with all other casualties of war. Once the shot design was locked, our technical team could determine meaningful ways to incorporate our process with the story.

Truck Asset & Photogrammetry -

Our VP supervisor knew that the use of photogrammetry would elevate the quality and overall look of our project from early days.



The image above is from the original capture session.

He proactively scanned our truck, amongst other key props and characters, by taking over 2,000 images of the interior and exterior of the vehicle.



Using a Silverdraft Demon workstation to process the data, our VP supervisor produced a high-quality 3D reproduction of the truck in very little time.

We were immediately able to use the virtual truck asset in several ways:

- Truck Asset delivered to ICVR
- Truck Asset delivered to Halon
- Truck Asset uploaded to Sketchfab
 - For simple 3D Model review
 - For use with AR feature allowing anyone with a smart phone/device place the asset in a physical location, manipulate scale, and physically walk around the object during both remote virtual scouting sessions and in-person scouting sessions.



Truck Asset: Virtual Scouting, Visualization, & Final In-Cam VFX -

Virtual Scouting with our truck asset played a critical role in *Ripple Effect's* remote workflow. Our creative team was able to virtually scout environments built by ICVR and Halon's VAD teams with a scale accurate version of our virtual truck from their own homes.

Our remote workflows continued as we moved into our visualization phase, allowing for accurate character and camera blocking in relation to the truck during remote sessions in Epic Game's Unreal Engine and via Zoom meetings.

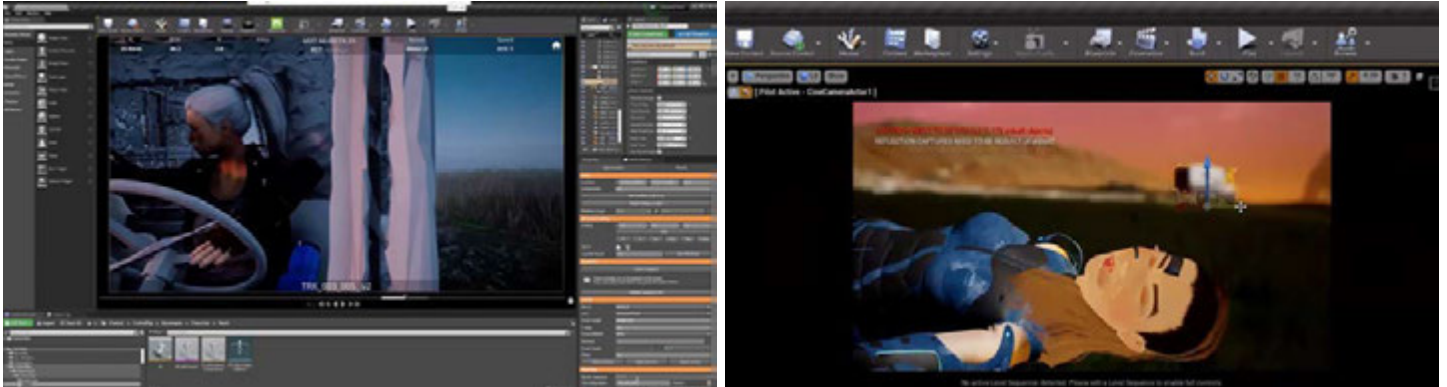

In visualization sessions with ICVR, our DP was able to work with a Glassbox Technologies Dragonfly virtual camera system using an iPad to frame shots in real-time for our directors. Within his own home, he was able to physically frame shots inside and outside the truck and plan the transition of Pip and Gary from the vehicle to the Battlefield environment. During visualization sessions with Halon, their VP supervisor drove the camera placement for sessions, streamlining the process and recording exact camera placements for our stage operating team to access on set. The DP and directors were able to focus on shot composition, lens choices, and depth of field, thinking through each creative decision and discussing how these choices would be impacted by the LED wall itself.

As depicted in the image below, Halon's supervisor would share the view from our camera's lens, a wide view of the virtual world and the stage's orientation in the world, as well as wider view correctly oriented from the position of the camera to the LED wall.

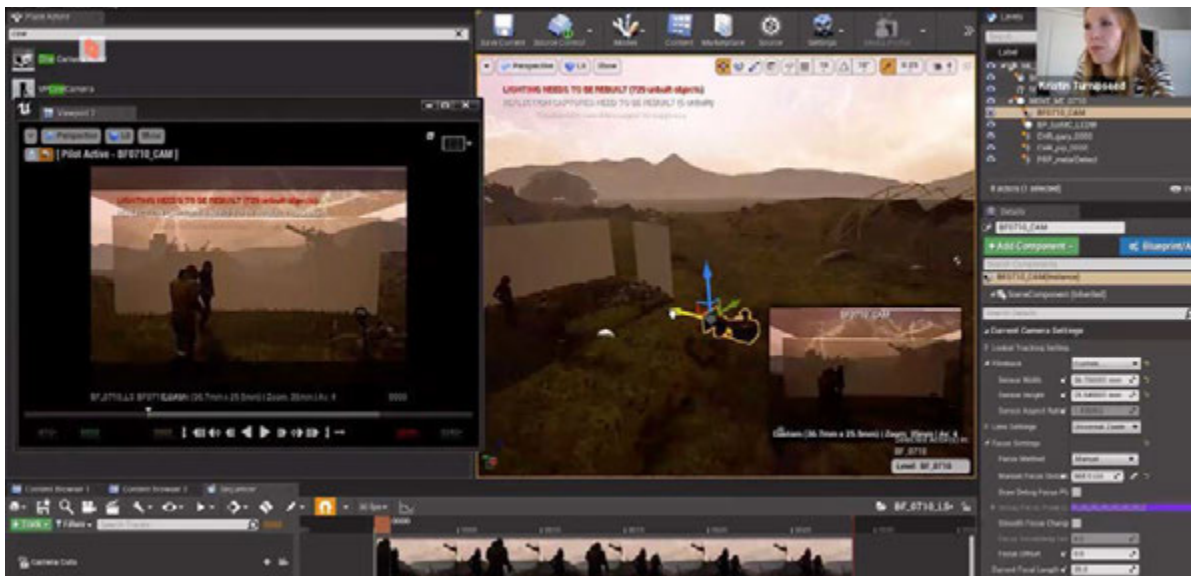

Halon VP supervisor, Kristin Turnipseed leading a remote visualization session.

As our team began physical testing in front of the LED wall, the truck asset could be accessed using Sketchfab's AR feature. Our DP and VP supervisor were able to use this tool on set at XR Stage to demonstrate shots and communicate our vision to stakeholders, the Stargate Studios team, and Digital Domain, who was consulting as our post visual effects vendor at the time.

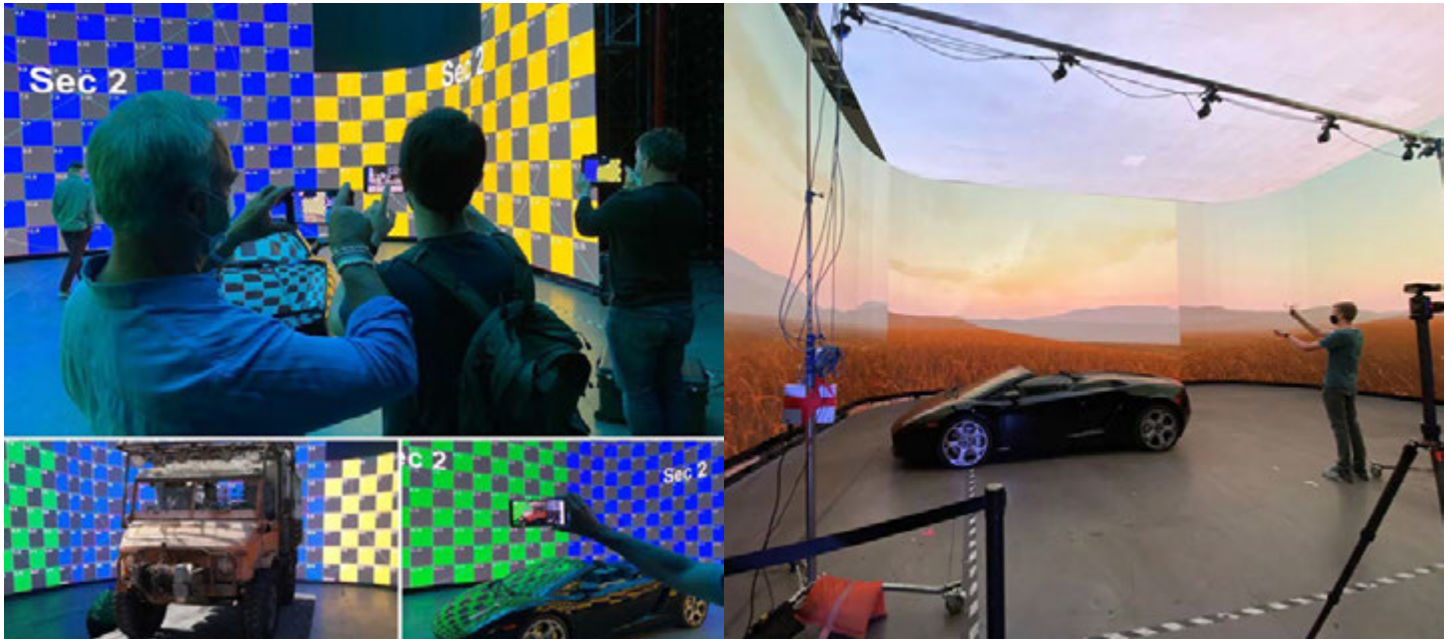

During many of our early testing days, XR Stage had a Lamborghini parked in the volume for general camera testing procedures. (Right Image Above, Stargate Studios sets up Camera Tracking System) Using Sketchfab AR, we were able to virtually replace the Lamborghini with our virtual 3D truck asset. (Left Image Above - Emre Okten, Sam Nicholson, Eric Robertson)



Emre Okten, a virtual cinematographer, looks through the back cabin of our virtual truck asset using the Sketchfab AR feature on a tablet. Holding the virtual camera tracking wand in his left hand, the horizon line of the virtual content is at the exact level of his virtual camera's lens.

Sketchfab AR was an essential tool in our creative process on set during testing because our team discovered that they could plan more exterior shots and interaction with the truck than assumed during our script breakdown and storyboarding phase. When the directors added exterior shots to our XR Stage shooting days, it restructured how they planned to transition into the Battlefield scenes. It informed what Use Case 13 and the order in which that shot would be placed in the final film.



As we moved into our stage-testing phase for the Battlefield sequence, our DP and directors used the techvis provided by Halon to begin physically creating their shots on stage.

The image to the right shows our DP standing in for cyborg Ara as he and the directors discuss camera position and blocking for Use Case 13.

We did not have access to a full costume stand-in until the day of the shoot and used a mannequin to frame our shot during testing.

Animated Asset Captured In-Camera

With our limited pre-production schedule we did not have enough time budgeted for a modeler to fully retopologize our truck asset. During our techvis phase with Halon, we were able to determine that committing to our sharpest focal plane being on Ara's face, she would be positioned far enough away from the LED wall that we did not need a photoreal, high-resolution model of the truck. Because we could also pre-plan the truck's animated path on the road behind Ara, we were able to manipulate our landscape along the road's edge to showcase the top of the truck and not its wheels. We did not retopologize or rig the vehicle, which limited the type of animation we could apply to its body and wheels.

Below the image to the left shows Kris Murray, CTO Lux Machina adjusting key frame animation on our vehicle as our VP supervisor provided direction reviewing the animation live, in real-time through the camera on the LED wall. The image below to the right shows Jason of Lux Machina working with our VP supervisor, Reiner Gombos (to his right) and Kristin Turnipseed from Halon remoting in on the laptop to his left. The whole team worked together to perfect the animation, timing, position, and lighting on set.



When the truck animation proved to be successful, the team was able to not only shoot the nodal static version of the shot that was originally techvised with Halon, they were also able to capture a few takes with movement on the dolly.

Without being able to physically prove that we would be able to “sell” a photogrammetry asset that had not been retopologized or rigged for animation to Halon was very challenging. When working with any vendor, it is important that they are just as confident about the process and end result as the client. With careful planning and communication, we were able to plan and execute a process that could have been very risky otherwise. This is an example of a workflow, that when carefully planned, could be executed on an independent film or project that has limited time, budget, and resources.



The VP team, AD, and DP rehearse the truck animation to time action.

Client & Vendor Org Chart

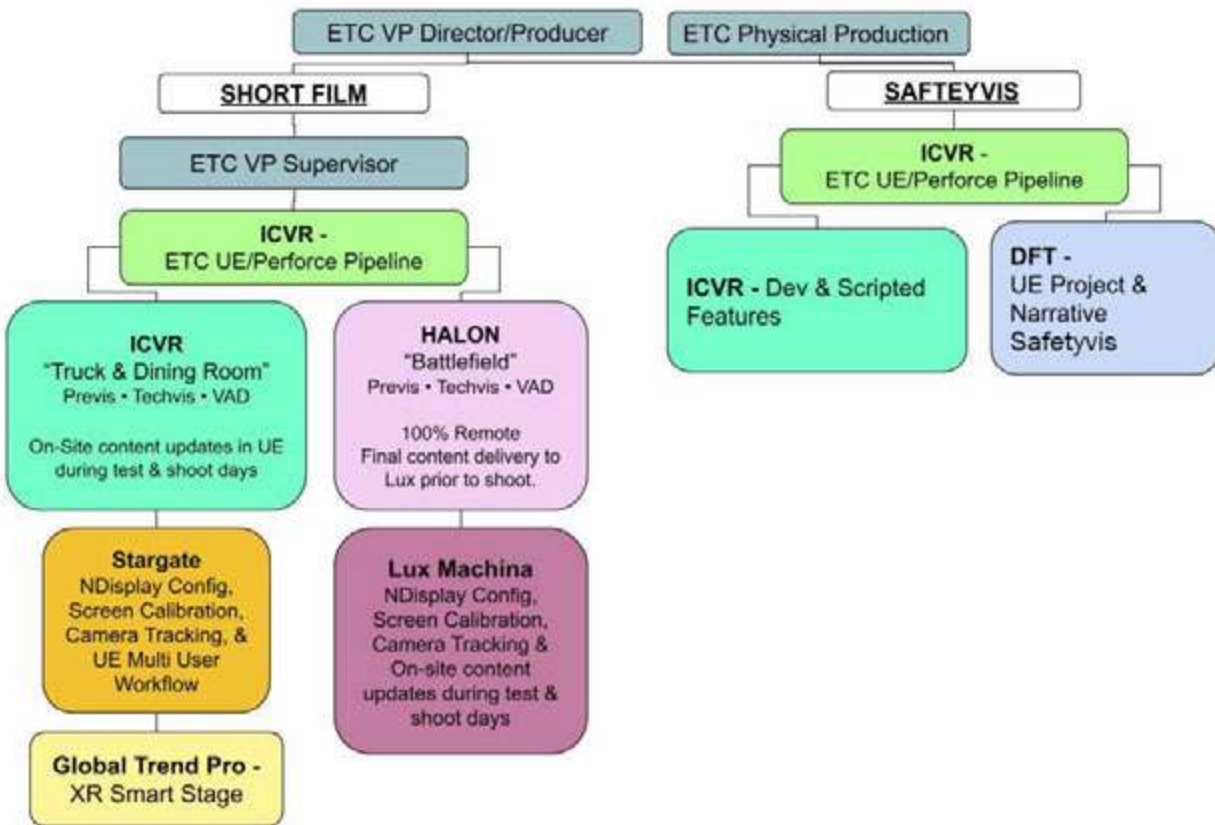

COST & PROJECTIONS

DEVELOPMENT Flow Chart

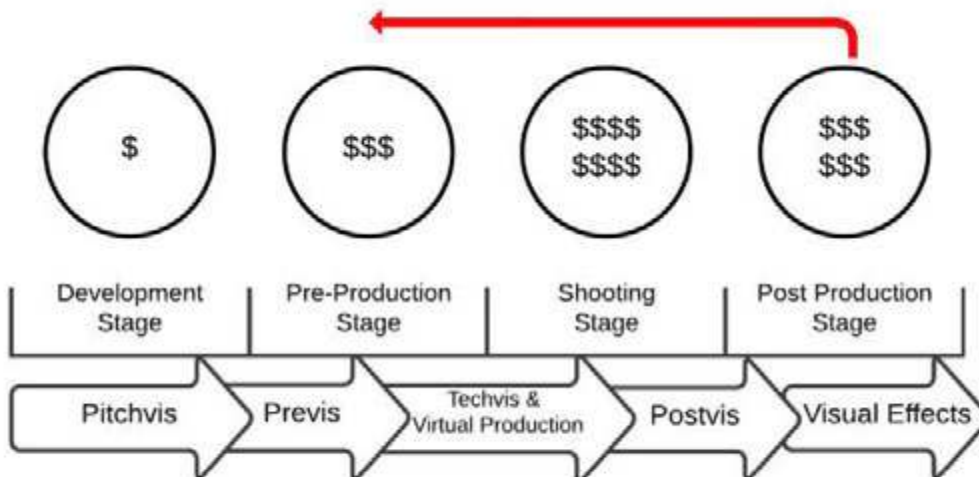

Production Expenses Infographic.
Courtesy of © The Third Floor, all rights reserved.
Modified for Ripple Effect Film.

How is setting up a virtual production workflow different than setting up a traditional production?

- First, we are going to re-allocate at least two-third of our post visual effects resources to the pre-production stage.
- The pre-production stage is going to be much longer to account for early in-camera effects workflows, stage testing, and pipeline construction.
- Then, we are going to integrate real-time game engines during pre-production and shooting on stage. (Bringing computer language, development, and technical challenges to set)
- Our goal is to walk away from our shoot days with final shots - no additional post VFX needed.

We were able to save money in post because we committed to our process early on.

A cost comparison for using an LED wall vs. greenscreen should be determined by the creative challenges a team is tasked with solving. First, it is important to identify the complexities that each methodology adds or subtracts from the process. Using this information as a guide, production can fill in the human and technical resources needed to achieve specific creative goals and map out a scheduled plan.

On *Ripple Effect*, we only captured “final pixel” in-camera VFX for display on LED walls and did not plan for traditional greenscreen or greenscreen frustum shots (using LED walls) into our workflows.

“Fix it in Prep” and “Fix it in Post” are two different philosophies that can both be applied to either an LED wall or traditional greenscreen workflow. There are pros and cons for either which can impact schedule, cost, and savings.

“Fix it in Prep” is a phrase and philosophy used over the years from experience working as a DP on set and VFX producer in an effort to get creatives to think through more efficient workflows. The visual effects community at large has used that phrase, “Fix it in Prep”, for a few decades in reaction to filmmakers capitalizing on the technological developments made in post VFX that allowed flexibility (technically and financially) for them to “make their shoot days” and “fix shots in post.”

Virtual production workflows, techniques, and tools should provide a path toward balancing the two philosophies. “Fix it in Prep” isn’t a new philosophy, only a newly popular one, again due to advances in real-time game engine technology that bring post VFX into prep and production.

Today it seems to have become an anthem for “non-destructive workflows” and “efficiency”, however using any workflow, tool, and technique as a “catch-all” doesn’t necessarily uphold these ideals.

Instead of one workflow replacing the other, we should consider each a separate tool that when used to its full potential can be extremely useful.

LED Walls that Display Real-Time or Pre-Rendered Content

Pros:

- Content displayed on LED walls is visible to everyone on set including talent, director, dept heads, production, crew, stakeholders, etc. When everyone can see what the content is at the same time, it helps with communicating the creative intent.
- Actors can interact with content on the volume.
- Brings more collaboration into the development phase between directors and key department heads. The more decisions that are finalized while key players are working together, (instead of during

the post process, when roles such as the production designer or DP have moved on to another project) the more they can iterate together to make the strongest creative decisions.

- Real-Time Visualization Techniques help creatives iterate faster. This ultimately lowers the cost of a project because it does not require the same cash flow as starting the full project. Many key creative decisions can be made in advance as well as the ability to solve complex technical challenges that also require advanced planning.
- COVID Safety - Production can ensure less individuals on physical sets and structure the day with less individual interaction between departments.
- Remote Workflows - Directors, production, department heads, and stakeholders can see the creative and understand its intent as it is displayed on the LED walls with minimal latency, allowing for remote participation on set. This positively impacts schedule as those working remotely may not need to provide input all day, they may only need to join in at specific times.
- Scope and Scale of Travel - The use of volumetric capture techniques to re-create exotic landscapes or basic city streets can reduce the size of the crew that travels to those locations. Capturing locations for use on a studio backlot will also mean less permit fees and periphery expenses associated with production needs on location. Bringing locations to a studio backlot also improves scheduling flexibility. If dialogue requires re-shoot in a specific location, the studio can display the environment as needed and capture any missing content.
- Opportunity for more diversity in the industry. There will be more job opportunities opening up in pipeline development as well as new roles that require unique skill sets.

Cons:

- If production is not able to commit to a “fix it in prep” philosophy, there may be additional costs in post and post VFX.
- There are currently a limited amount of operational smart stage LED volumes available for use.
- The limited availability of smart stage LED volumes makes their rental costs very high.
- The physical testing phase of a project shot in a smart stage LED volume requires precise set-up, device profiling, system calibration, and stage operation. It is ideal to have access to a stage throughout the creative visualization process to troubleshoot and prepare for final shoot days.
- Few smart stage volumes are also sound stages.
- There are a limited number of professionals trained in smart stage volume workflows.
- Introducing computers on set to run the display systems and content, introduce new technical issues such as overheating and power outages to set.

LED Walls that Display Greenscreen Frustum in Real-Time

(See above) & Additionally...

Pros:

- Using an LED wall to display greenscreen, whether it is full screen or only a limited frustum, significantly reduces green spill lighting on talent and sets.
- Greenscreen frustum workflows increase the amount of lighting from the practical and virtual environment on talent and sets which produce accurate reflections captured in-camera.
- Camera Tracking metadata can be captured on set and provided to the post VFX vendor to reduce time to track shots in post. This is especially cost effective if the shots captured would require extensive 3D tracking.

Traditional Greenscreen Stage

Using traditional greenscreen methodologies have been extensively documented, tested, and have established metrics with which one can schedule and budget.

For creatives whose process needs to develop over a longer period of time or would not thrive in an LED wall workflow, using traditional greenscreen might be the best fit.

Pros:

- Creative content can replace the greenscreen in post. This does not have to be complete before physical production.
- Depending on the physical build of the greenscreen itself, it may be faster to build and move.
- Ideal for use on location or in a studio.
- Additional power is not needed for greenscreen fabric or painted walls.

Cons:

- Green spill appears on talent and sets.
- Accurate interactive reflections need to be added in post.
- Actors cannot see what they are interacting with and this may affect performance.
- Department heads such as production designer and DP may not be involved with key creative decisions as related to shot design and composition as these may be made in post.

Content Complexity & Scope

It is important to take into account what type of content will be displayed on either the LED wall or greenscreen and the complexity of the process with which it takes to generate the content. This will also impact cost.

For example, creating unique 3D CG worlds in advance of shoot, to render in real-time on LED walls, in order to capture “final pixel” in-camera effects significantly increases the complexity to pre-production and production phase of a project. It also requires a high level of commitment to the process to show cost savings.

The list below shows a suggested progression of content that ranges from least to most complexity and scope. The methodology for how content is displayed on an LED wall can also add complexity to device profiling, hardware set-up, system calibration, and the creative process in general.

Pre-rendered content is least complex because we are able to control more variables.

1	Test Patterns / Color Charts
2	Photographic Content Captured by Camera
3	Photographic Content Captured by Camera Using Photogrammetry and Reconstructed as Still or Pre-Rendered Plate
4	Pre-Rendered Content - Visualization / VAD Team
5	Pre-Rendered Content - VFX Team
6	Real-Time Rendered 2D (and 1/2) Content - Visualization / VAD Team
7	Real-Time Rendered 2D (and 1/2) Content - VFX Team
8	Real-Time Rendered 3D Content - Visualization / VAD Team
9	Real-Time Rendered 3D Content - VFX Team
10	Real-Time Rendered 3D Content w/ Greenscreen Frustum - Visualization / VAD Team
11	Real-Time Rendered 3D Content w/ Greenscreen Frustum - VFX Team

When developing best practices for your virtual production team, testing these content types in order from 1 to 11 to help isolate findings is strongly suggested.

Regarding scope, it is also important to consider the level of interaction between the physical and virtual world, matching production design between the physical and virtual world, dynamic camera movements, SPFX integration, etc., as these all add complexity to setup.

Virtual Production Team

Virtual Production should be considered an integral part of “physical production,” not a separate entity. The concept of virtual production as a separate entity exists today because virtual production tools, techniques, and workflows applied to physical production require new skill sets, an adoption of computing and computer language on set, and team leadership with a strong understanding of visual effects.

The goal for our industry should be to educate existing departments to help them acquire skills in computing and real-time technology and ensure that baseline visual effects knowledge is a minimum requirement. Creative should drive a project and determine the technical challenges that need to be solved by project leadership and department heads.

It is important to hire individuals whose combined skill sets and experience match those technical challenges. It is critical that project leadership and department heads are exact in their approach to problem solving. Over and/or under estimating a technical challenge and its solution can negatively impact a project budget and cause other issues with compounding consequences.

As is with traditional VFX workflows, in-camera effects require strong creative vision, vendor setup time, technical pipeline development, reviews, an approval process, and delivery method. For projects where the goal is to capture “final pixel” in-camera effects using LED walls as backgrounds, a significant portion of the VFX work on the project will take place in the pre-production phase. Shifting visual effects work into pre-production phase means that creative decisions (be project leadership, stakeholders, and department heads) need to happen at a faster pace and take place earlier in the process before testing and shooting phases begin.

Virtual Production Org Chart

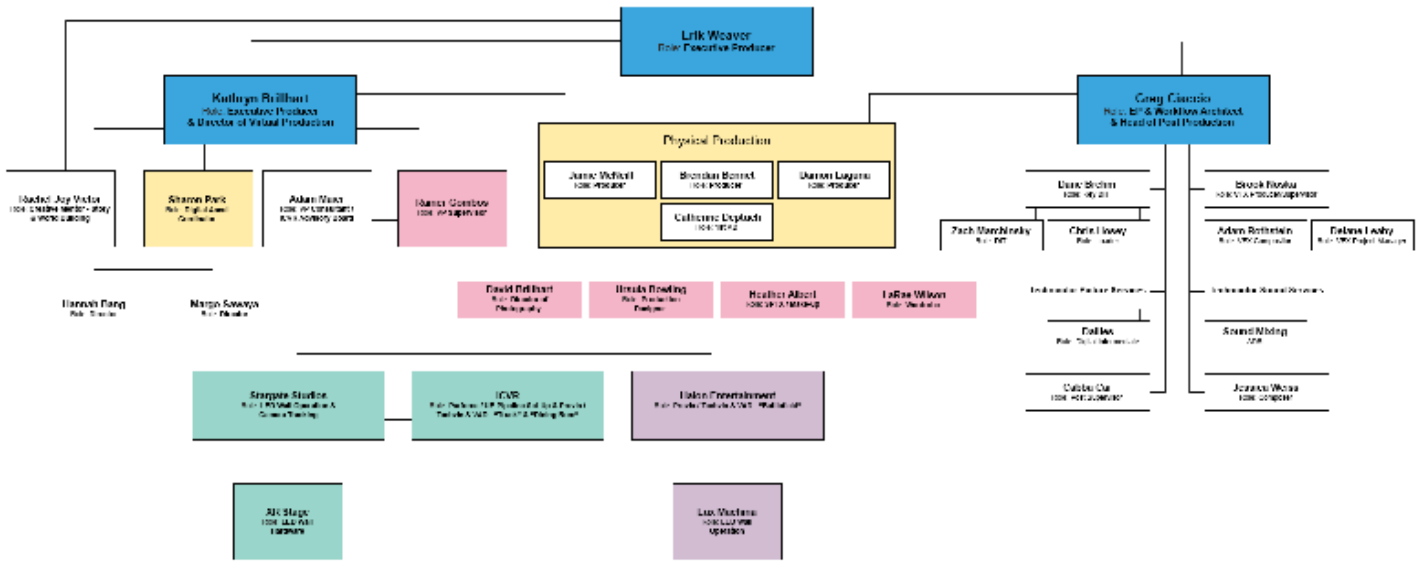

Ripple Effect VP Department Roles

The Virtual Production Department on Ripple Effect consisted of a small core team: VP producer & director, VP supervisor, and digital asset coordinator.

The project relied on donated resources and volunteer support which impacted how we were able to staff and organize these contributions.

The virtual production team positions on this film were modeled as if ETC were a studio. We formed a small core team to steer the direction of the project and hired vendors to execute specific technical and creative aspects of the project. For independent films or smaller groups, it may be more beneficial to build a core team with more overlap in skill sets as it may not be possible to work with as many vendors or hire individual positions on a project.

Virtual Production Department Org Chart

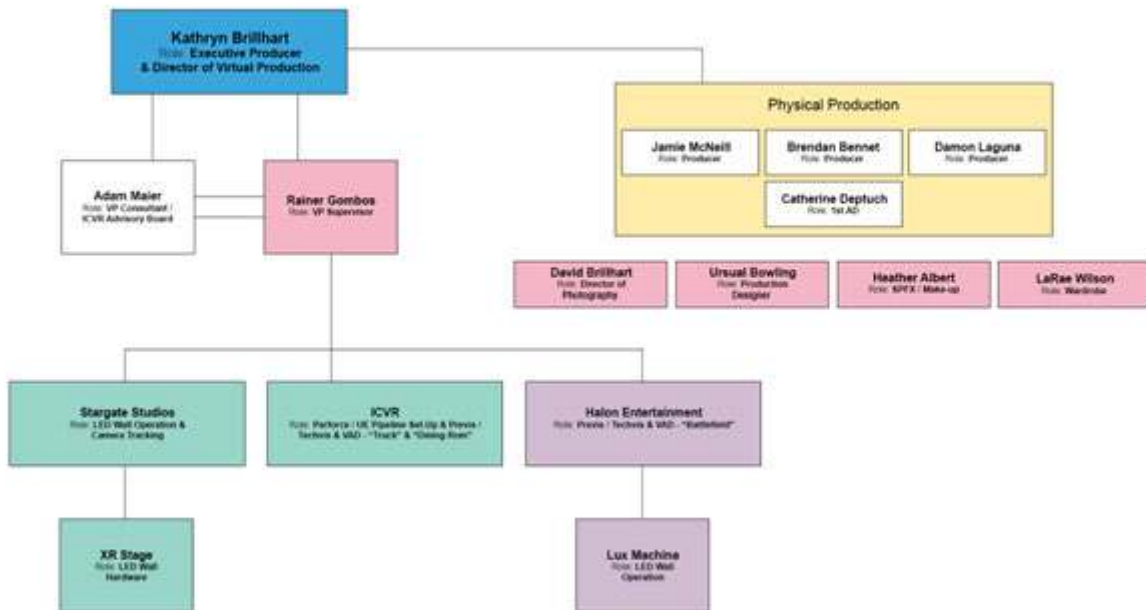

Executive Director & Producer of Virtual Production

Both a creative and technical Head of Production role, the VP director/producer is responsible for the mechanical making of the film as it relates to virtual production, including the creative process, budgeting, and planning, through execution. The position bridges the gap between the filmmakers and VFX throughout the production pipeline.

During development and pre-production, they assist the director and department leads to understand and make decisions about virtual production workflows and shooting methods. The VP director/producer interfaces with all departments to ensure that assets arrive on set the best way possible for the intended virtual production. This includes managing all VP vendor relationships and ensuring the entire production stays informed and on schedule.

The VP director/producer must be in tight collaboration with the VP supervisor, DP, and production design to ensure consistent visual quality and achieve the creative aims of the director(s) and or producers. They provide the creative leadership needed to both set the expectation for the highest levels of quality for all areas of art among a team of dynamic artists and stakeholders. And given that some of the technology is still in its relative infancy, this often not only means pushing for the highest possible quality, but also setting expectations for what can realistically be achieved within the means of the budget and technology, or services employed.

Virtual Production Supervisor

The VP supervisor acts as a partner to the VP director/producer and is responsible for ensuring technical continuity and consistent/high visual quality from vendor deliverables, and the content that plays back during physical test and shoot days. They collaborate with the VP director/producer on how best to creatively execute the director's vision within the determined scope.

The VP supervisor should be involved in as many of the technical and creative discussions as possible to understand any details that may influence the production. They are responsible for keeping the entire production team informed of progress, changes, roadblocks, or other critical issues.

They need to be capable of resolving asset pipeline issues and streamlining the process, and be able to research, identify, and implement solutions on the fly in prep and during production. This role can require experience in VFX supervision (post & on set), CG supervision, design/composition, volumetric capture, performance capture, and real-time rendering (game engine) workflows, in addition to standard production processes.

[THIS ROLE NEEDS TO BE SPLIT INTO TWO ROLES]

Important Skills: VFX Supervision (Post & On Set), CG Supervision, Design/Composition, Volumetric Capture Workflows, Real-Time Supervision.

Pipeline Technical Director/Workflow Supervisor

The Pipeline technical director/Workflow supervisor is responsible for setting up the game engine, asset/version control repository, and individual workspace access for each vendor. And they create and update vendor setup and workflow documentation.

They provide technical support for hardware, software, and technical services vendors working to support the VP director/producer and VP supervisor.

Digital Asset Coordinator

The Digital Asset Coordinator manages asset organization and ingestion to the production resource databases. They collect and organize any media and assets originating from various sources, making them available as needed. It is important they are able to attend or monitor any technical or creative discussions, including but not limited to Slack/email communications.

Ideal Roles (per our findings on *Ripple Effect*)

Are other additional roles needed on a VP team?

Real-time CG Supervisor

A dedicated CG supervisor (client side) is an important role to include on a VP team. Although our VP supervisor has extensive background in this role, we did not have someone on our team who could guide the technical process for our vendors on a daily basis and QC their work full time. The CG supervisor would also be able to run separate technical reviews that could inform notes that we bring to the creative process. They could work with the stage operation team and VAD vendors in advance to minimize content calibration and testing on set. Much more work could have been accomplished remotely. They would be helpful to have on set as well interfacing with the VAD team, stage operators, and VP supervisor to process additional photogrammetry on the fly or even help manipulate assets and lighting in real-time.

Pipeline Technical Director / Blueprinter

Hiring a dedicated pipeline technical director will open up opportunities to build proprietary toolsets for the CG and VP supervisor during pre-production and production. If there are blueprints, scripts, or digital tools developed for remote workflows in game engine, these can also be applied to work on set. From a studio perspective, this role is important because the tools can be used multiple times and on future projects increasing their return on investment.

Suggested Minimum Crew Needed On Set for LED Wall Shoot

- Virtual Production Supervision/Direction
- Camera Dept: DP, Camera Op, 1AC, DIT (more..?)
- Smart Stage Crew: Stage Operator
- Content Playback: Playback/Content Operator
- Visual Effects Supervision
- VAD/Real-Time Content Playback
- Who is on set and who is remote?

Virtual Production Department Org Chart
Client Team Structure for Workflow -
Capturing Final Pixel In-Camera VFX Using Real-Time Game Engine Technology & LED Walls

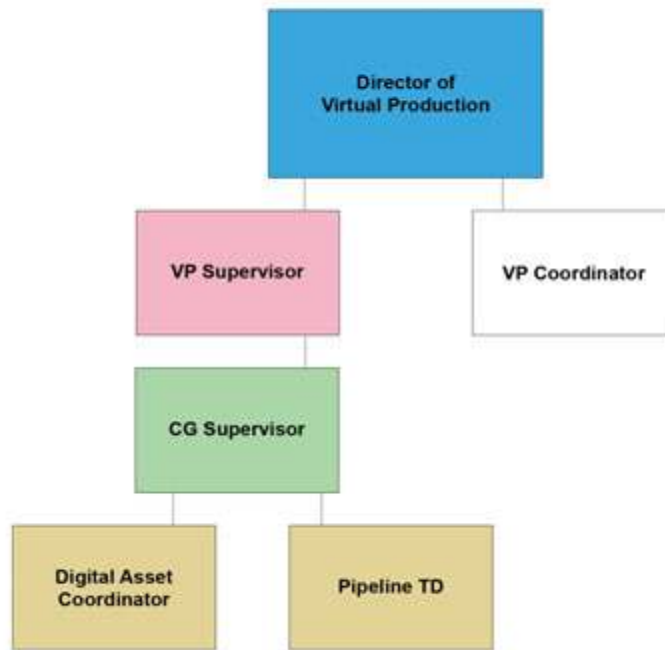

Virtual Production Department Org Chart
Client Team Structure for Workflow -
Capturing Final Pixel In-Camera VFX Using Real-Time Game Engine Technology & LED Walls

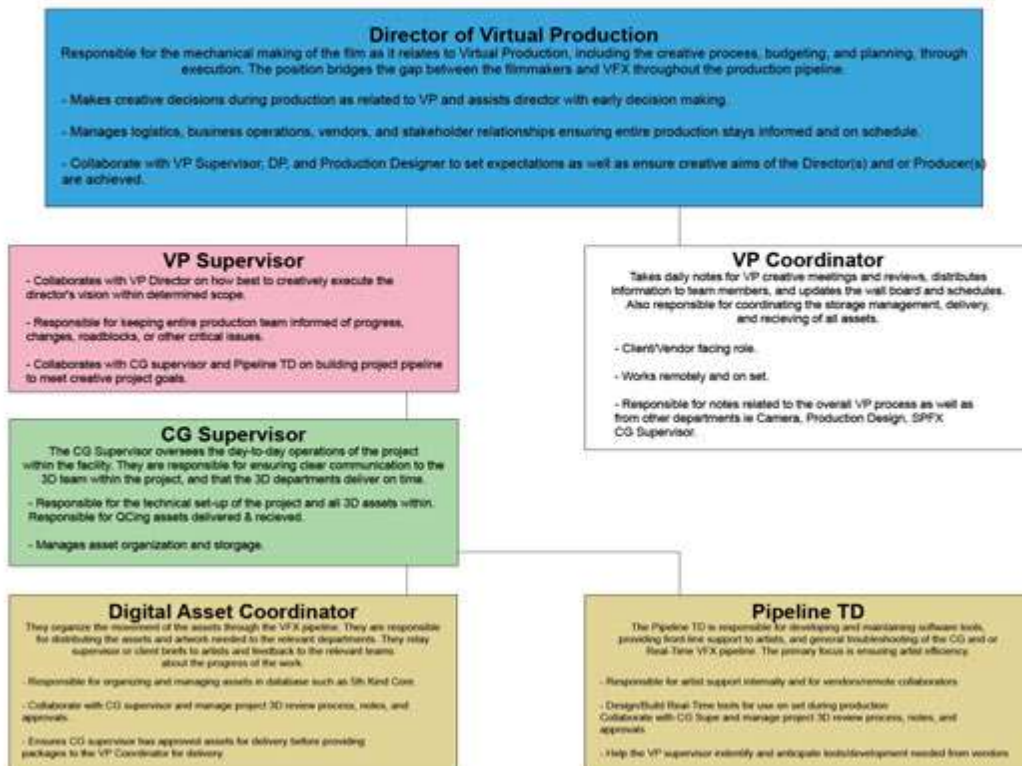

INTEGRATION WITH PHYSICAL PRODUCTION PLANNING SYSTEMS (PROJECT MANAGEMENT / COST TRACKING)

On *Ripple Effect*, our ETC team hired a director of virtual production to provide script breakdowns, vendor requirements/SOWs, consultation, and team management to guide the early stages of development and prepare our visualization vendors for both pre-production and production phases of the project.

The combination of “client side” Virtual Production, Cinematography, Workflow, and VFX expertise set our team up for highest cost savings. We were able to set specific creative and technical “client side” goals for our project that could be used to determine initial Time & Materials cost estimates that could then be tracked “up or down” as we moved into our visualization process.

The cost/logistics trade-offs can be tracked using standard VFX production management tools such as Shotgun Software, ftrack etc. to keep track of financial goals from a “client side” and a “vendor side.” Managing cost as the plan changes is similar to physical production and VFX project management and you need both types of experience to anticipate complexity when budgeting.

Note: Are any of the above integrated into Movie Magic? If not, they should be, as studios move through their budgets from the top down, and adding VP headers and detail line costs will help raise awareness and help to establish VP processes/costs as SOP where pertinent.

Other note on integrations: We did create integrations centered with 5th Kind, to most of the development process. All integrated tools to 5th Kind, Bluescape, Avalanche, Teradek, ScriptE, Colorfront and Perforce Helix Core version control. Leveraging a rudimentary framework with C4.

Important Skills: VFX Producing, VFX Supervision (Post & OnSet), Cinematography, Volumetric Capture Workflows, Real-Time Project Management/Supervision.

DEVELOPMENT

SCRIPT

Concept Art

ICVR helped our directors create early concept art for each location. Creating visuals to help communicate creative intent is essential in the visual effects process whether they are captured in camera or added in post. A production designer can use images like this to unite VFX and VAD teams toward a common goal.



Storyboards

[Link to Deck with Compiled Storyboards](#)

The VP director compiled the latest storyboards from Bluescape and the camera shot list for the first DP when he came on board (week 5). He was asked to use these as a starting point and help finish storyboarding/shot listing with directors.

Game engines make it possible to design and save shots in real-time (previs), bypassing traditional 2D storyboards. This choice will depend on the complexity of the project, skill level/working style of the director/DP, and the project schedule/budget.

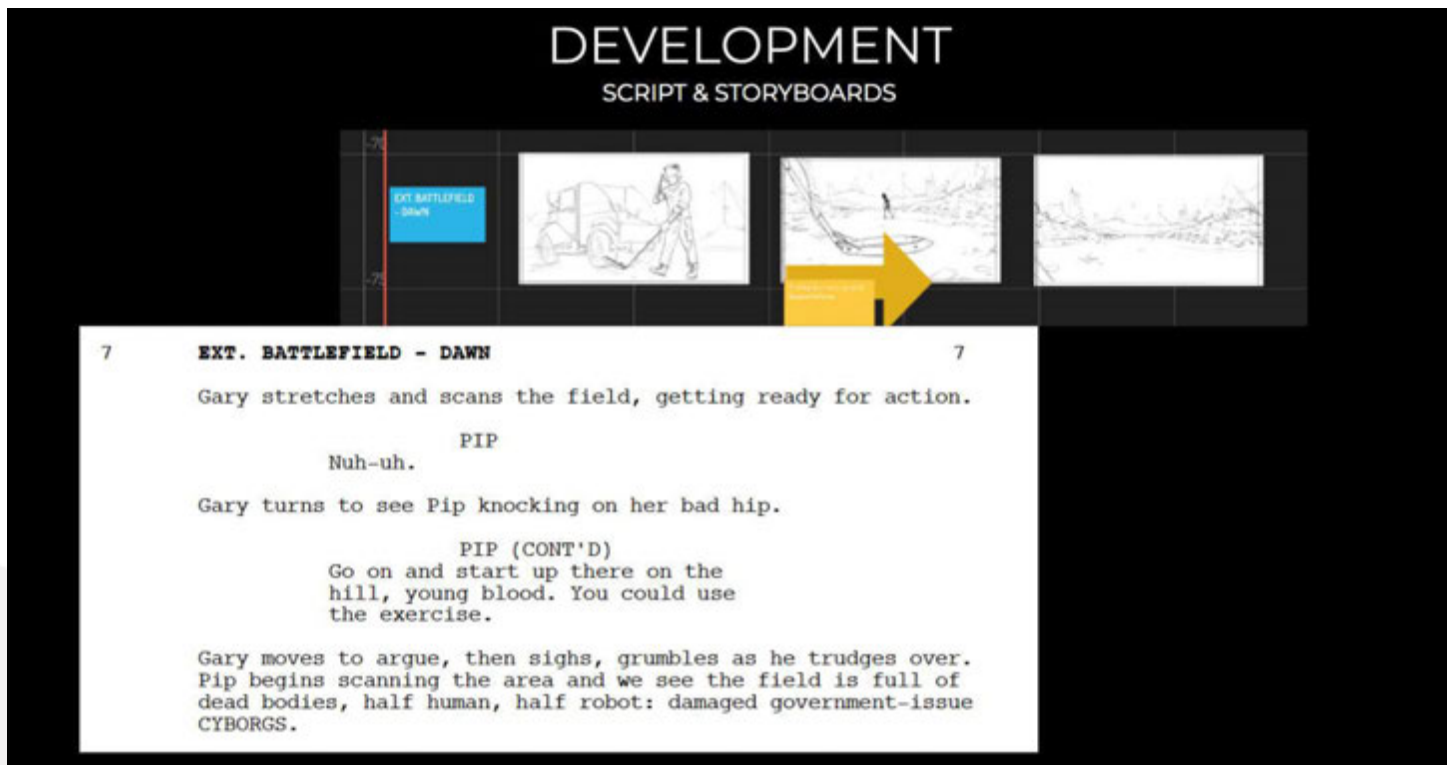

DEVELOPMENT
SCRIPT & STORYBOARDS

7 **EXT. BATTLEFIELD - DAWN** 7

Gary stretches and scans the field, getting ready for action.

PIP
Nuh-uh.

Gary turns to see Pip knocking on her bad hip.

PIP (CONT'D)
Go on and start up there on the hill, young blood. You could use the exercise.

Gary moves to argue, then sighs, grumbles as he trudges over. Pip begins scanning the area and we see the field is full of dead bodies, half human, half robot: damaged government-issue CYBORGS.

SCRIPT BREAKDOWN

Create Asset Lists

Asset List

File 187 View Search Filter 2478 1888 Add and More

Date created: 07/20

Date updated: 11/20

PHYSICAL ASSETS

Environment	Name	Physical / Model Prop	STATUS	NOTES	Website
Dining Room int	Woolen	Physical			
Dining Room int	Speakers/Fade	Physical			
Dining Room int	Clock	Physical			http://www.alexandria.com/interiors/2016/06/24/alexandria-2016-06-24/
Dining Room int	Kitchen hoodtop	Physical			http://www.alexandria.com/interiors/2016/06/24/alexandria-2016-06-24/
Dining Room int	Paint	Physical			
Dining Room int	Surf rock	Physical			
Battlefield	Woolens	Physical	Needs to match CG Model?		http://www.alexandria.com/interiors/2016/06/24/alexandria-2016-06-24/
Battlefield	Furpad	Physical	Needs to match CG Model?		http://www.alexandria.com/interiors/2016/06/24/alexandria-2016-06-24/
Battlefield	Iron Kettle	Physical	Needs to match CG Model?		http://www.alexandria.com/interiors/2016/06/24/alexandria-2016-06-24/
Battlefield	Metal Dishes	Physical	Needs to match CG Model?		http://www.alexandria.com/interiors/2016/06/24/alexandria-2016-06-24/
Battlefield	Colony	Physical	Needs to match CG Model?		
Battlefield	Flie in Dish Cajal	Physical			
Battlefield	Dead Air / Cooking Facing Cabinet	Physical			
Dining Room int	Phone	Physical			
Battlefield	Woolens	Physical			http://www.alexandria.com/interiors/2016/06/24/alexandria-2016-06-24/
Battlefield	Chair Text	Physical			
Battlefield	Iron Chip Cops	Physical			
Dining Room int	Table	Physical			
Dining Room int	Chairs	Physical			
Dining Room int	Table Settings	Physical			
Dining Room int	Dinner / Food	Physical			
Dining Room int	Kitchen	Physical			
Truck Exterior	Frontal Camera Cab	Physical			
Truck Interior	Steering Wheel	Physical			

ASSET LIST_PVR ASSET LIST_BY_ENV



CORE Ripple Effect

Browse Filter

File Search

Inbox

box Files

History

Transfers

Ripple Effect

- + Characters
- + CORE
- + Dailies
- + Live
- + Locations
- + Production
- VFX
 - Battlefield
 - + Concept Art
 - + Element
 - + Storyboards
 - + Dining Room

Ripple Effect / VFX / Battlefield / Element / Rocks / Reference

Mossy Rock_039.png 1.5 MB 08/12/2020

Mossy Rock_038.png 1.8 MB 08/12/2020

Mossy Rock_037.png 2.0 MB 08/12/2020

Mossy Rock_036.png 1.4 MB 08/12/2020

Script Breakdowns & Asset Lists

DEVELOPMENT Flowchart



Script



Concept Art/
Reference



Script Breakdown



Shot List



Asset List

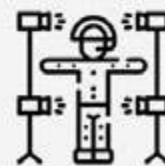

Mocap Shot List

Create Shot Lists

CAMERA SHOT LIST

File Edit View Insert Format Data Tools Help and More

Share

NO	SEQ	SCENE	SHOT	ENVIRONMENT	STATUS	IMAGE	IMAGE (CONT)	DESCRIPTION (from Creative Team)	Notes (from 'EP Updated about Jul 21/2020')
6	76A	001	015	TRUCK INT				CU following Gary's head as he walks up to his profile (and in Pig's POV)	World: Lighter green side is towards the direction of the destination. Organic transition into grey. Effects lighting on the watermarked as glass currents. LA windows within the houses in the distance. Family's houses will be illuminated as we drive further out.
7	76A	001	020	TRUCK INT				CU Pig in profile (Gary's POV)	Distance of (another) sides from road so that they are viewed from the perspective of the road.
7	76A	001	032	TRUCK INT				2-shot, front	Deal for signage: Government logo, slogan sign. Call out specific aspects that will need to be in the shot, so they can be in the correct location, timing etc.
8	76A	001	040	TRUCK INT				MIDDLE-NEAR shot	Fewer round houses, more farmhouses.
9	76A	001	050	TRUCK INT				Only medium on Gary from Pig's OTS	No more round houses, a few farmhouses. Here is where the sign and operators will be visible. Operator will begin to show us of the road. Fallen over the side and slumps.
10	07A	002	010	DINING ROOM				Wide Shot: Joy enters and it becomes her Medium	
11	07A	002	020	DINING ROOM				Reverse Medium on Kat	

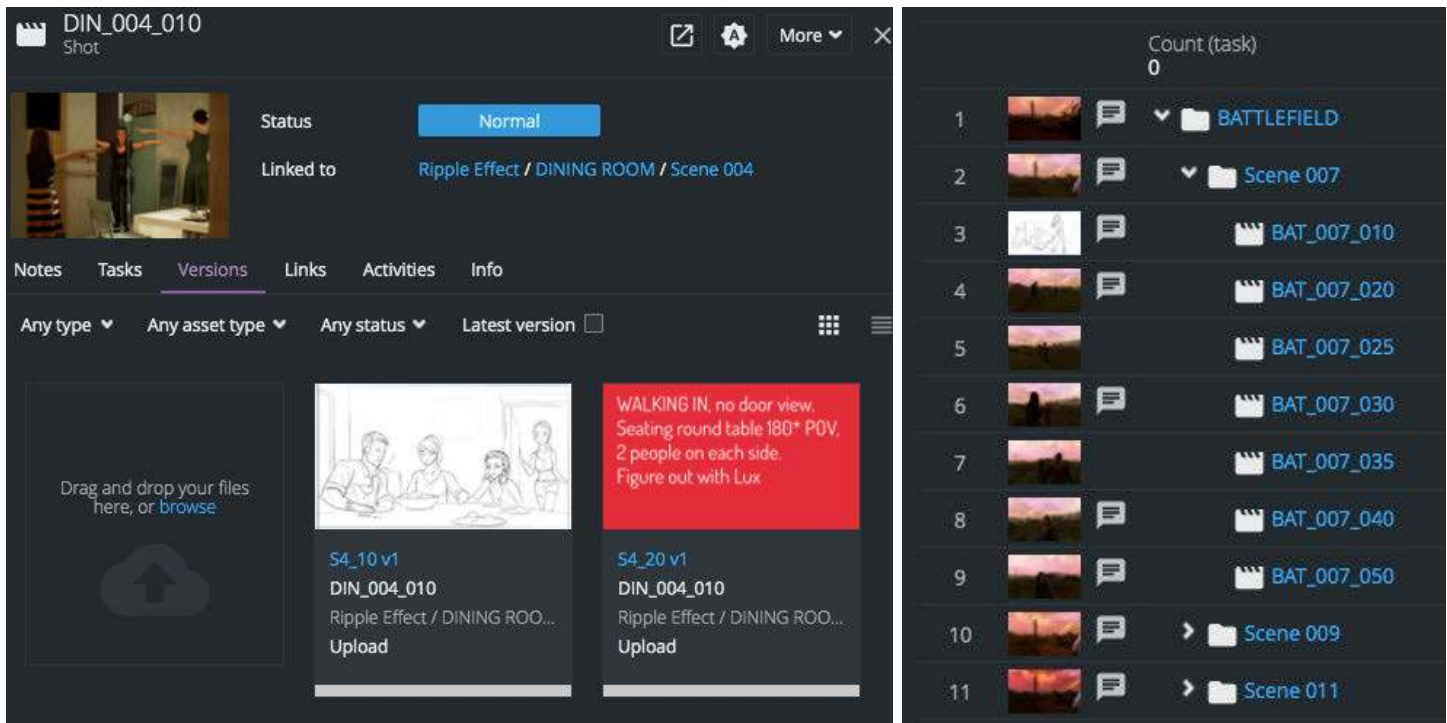

Virtual Production, Physical Production, and Visual Effects can be effectively planned for using a combination of industry standard tools. A virtual production project will benefit from using standard visual effects tools for organization, project management, and reviewing content.

Movie Magic - is a script breakdown and budgeting tool that has become somewhat of an industry standard.

Curo - is a script breakdown tool specifically designed for Visual Effects - scheduling, budgeting, and building asset lists.

Excel - is a 2D database that can be used to organize static data and update 3D databases.

FileMakerPro - often used by VFX editors for shot management.

Shotgun Software - Visual Effects industry standard 3D database that can be updated live, is custom viewable to artists/ productions, is a review tool, is a budget/time tracking tool - centralizes all project info.

ftrack - a 3D database that centralizes project info/reviews/is intended for similar use as Shotgun Software - its structure uses unique logic and visually organizes data in a folder/drawer format. (Not useful for *Ripple Effect* as there was no customization or automation provided).

5th Kind Asset Management Database - A high security 3D database specifically designed for tracking assets from beginning to end of a project. A team can store concept art, final assets, dailies from shoot days as well as track how all of these assets are connected.

What's missing - The game engine community needs an accurate, streamlined way for reviewing 3D content and for those associated notes to be properly, automatically assigned to the correct area of the 3D content and stored in a 3D database. These tools are currently available for 3D content with a 2D final output on streaming platforms, theatrical release, etc. We need the same tools for content that is either released in 3D or is supposed to be incorporated into scenes shot on LED walls on set. Additionally, this would be useful for any content reviewed in a VR headset.

From a CG/VFX supervisor POV, it is important to be able to review content independently and with artists knowing that each person sees 100% the same perspective, the same quality, and that any notes that are given would be properly assigned to the content in 3D space and that those notes would automatically be entered into the team database for production tracking, artist tracking, and task creation.

From a director's POV, a similar set of tools is needed to ensure that the supervisor and artists see exactly what the director is reviewing at the same time. Their notes and annotations need to be accurately stored in their team database as well for tracking. While these tools exist for VFX designed for 2D final output (ftrack's cineSync, for instance), they need to be built for game engines.

PRE- PRODUCTION

The development and pre-production phases are critical to a virtual production's success. This is time dedicated to story development, using visualization tools to iterate a director's vision, hiring key department heads, and awarding work to vendors. The timing of each of these components should be well thought out as it relates to the creative goals of the project.

On *Ripple Effect*, we had a very short timeline with only eight weeks leading up to production. Decisions needed to be made quickly and intentionally starting very early on in our process.

PREP WORK - DIRECTOR OF PHOTOGRAPHY

Creative Prep

(In addition to typical prep work, add the following...)

- Participate in previs and techvis sessions.
- If possible, work with the VP supervisor and/or CG supervisor to understand how virtual lighting setups will be constructed. Make sure tools are built for use on set that are intuitive to your needs.
- Design shot plans to the specific dimensions of the volume and account for the rotation of the virtual world. Standard overhead camera blocking maps are misleading and not the most accurate tool for this workflow.

Exhibit A: Standard Overhead Camera Blocking Maps

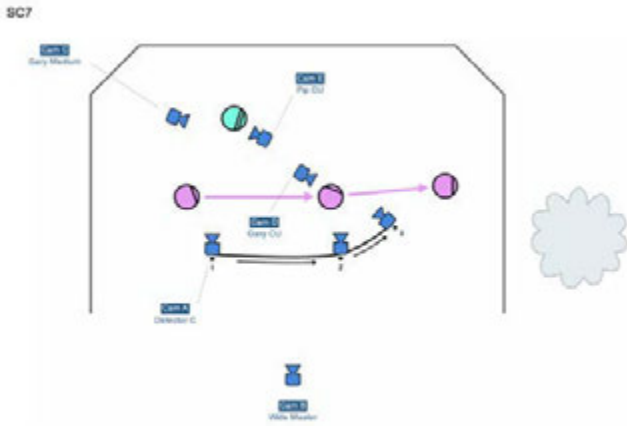

Printed Wed Jul 22 2020 04:41:12 PM

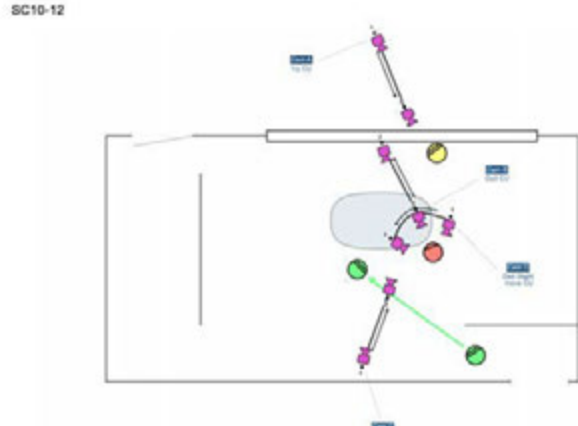

Printed Wed Jul 22 2020 04:41:26 PM

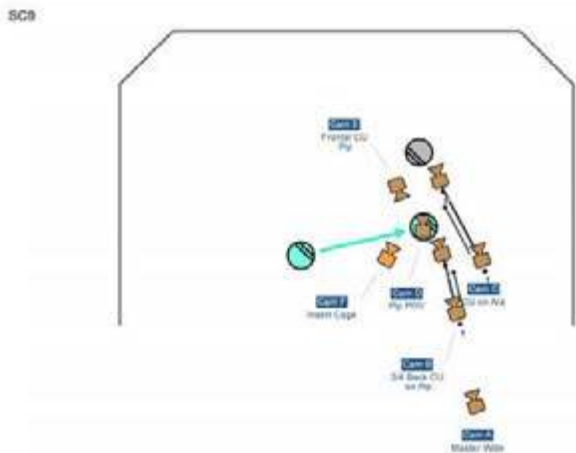

Printed Wed Jul 22 2020 04:41:21 PM

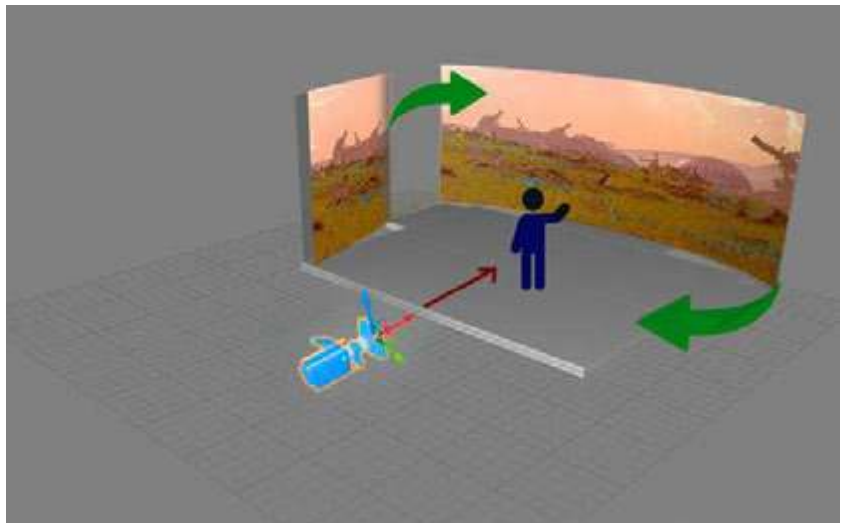

The DP needs to translate overhead view for shooting plan against LED walls. There are several variables that will impact a shot list and shooting strategy. The diagram above (lower right) is more effective than an overhead plan.

Exhibit B: Shot Plans Tailored to LED Volume

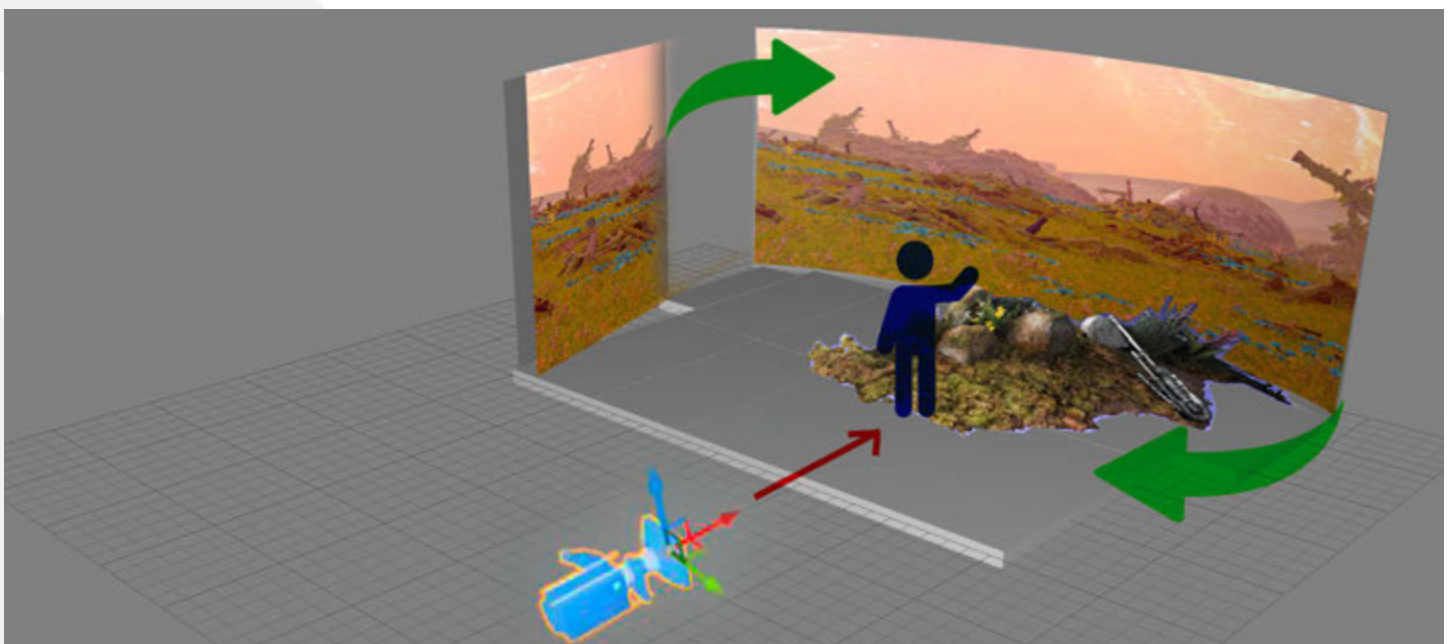

Prep for LED Volume

- DP will use provided visuals and measurements of the LED wall configuration to plan camera placements, movements, and iterate creative in advance.
- If possible, build a LUT with a colorist on the same LED wall configuration that will be used for final shoot. The goal is to match white emitted from virtual background with physical color chart.
- Schedule enough time in advance of the shoot to build out gear and profile devices.
- Once the camera and stage are profiled, they should be calibrated together.
- Participate in testing days and use the time to isolate errors, address screen artifacting, and strategize creative solutions for avoiding moiré.
- Establish a relationship with stage operator and content playback/real-time artist on set. These individuals impact the time it will take to set up your frame.
- Participate in decision making for which crew members are working on set or remotely.

Resources Needed

- Scale accurate diagram and measurements of the LED wall configuration.
- Specifications for LED wall panels, processing, and pre-rendered/real-time rendered content workflow.
- Virtual & physical color charts.
- Digital Test Patterns to help evaluate, isolate, and eliminate artifacting.

PREP WORK - PRODUCTION DESIGNER

Creative Prep

(In addition to typical prep work, add the following...)

- Participate in previs and techvis sessions.
- Make sure to request updated smart stage dimensions and measurements as the screen configuration may change during the pre-production phase.

Prep for LED Volume

- Production designer will use provided visuals and measurements of the LED wall configuration to plan camera placements, movements, and iterate creative in advance.
- Consider designing set pieces in a similar way to theater - ability to roll away or easy to move in pieces. Sets are expected to be broken down quickly to maximize time on stage.
- Schedule enough time in advance of the shoot to build sets and volumetrically capture to integrate virtual and physical sets.
- Participate in testing days to refine design, schedule, and plan.
- Establish a relationship with stage operator and content playback/real-time artist on set. These individuals impact your ability to manipulate the virtual world and playback content during set installation.
- Participate in decision making for which crew members are working on set or remotely.

VISUALIZATION

Previs

The story is determined by the script. Previs helps a director virtually scout a location, block a scene with digital avatars, and block camera placements to develop a shot list that a physical camera can match during the shoot.

Virtual Scouting

We implemented Virtual Scouting techniques in pre-production and production for *Ripple Effect*. In pre-production, our directors, production designer, DP, and producers worked with two visualization companies to design and build unique environments that would be displayed on smart stage LED walls. Both companies used unique virtual tools in Unreal Engine that allowed them to place cameras, block actors, and adjust the set/props/environment live during remote collaboration sessions. ICVR provided physical tools and training for our DP so that he could operate camera from home using the Glassbox “DragonFly” virtual camera system remotely during a multi-user game engine session.

Given the compressed timelines and resource availabilities on *Ripple Effect*, Halon’s visualization supervisor took the lead camera operating and placing cameras within the scene using custom Unreal Engine tools to show the directors different views while they addressed notes live - normally the responsibility of the DP and camera operator. They provided a wide view of the virtual camera being manipulated in the environment, and a view from the POV of the camera as well to show framing and depth of field per lens choices.

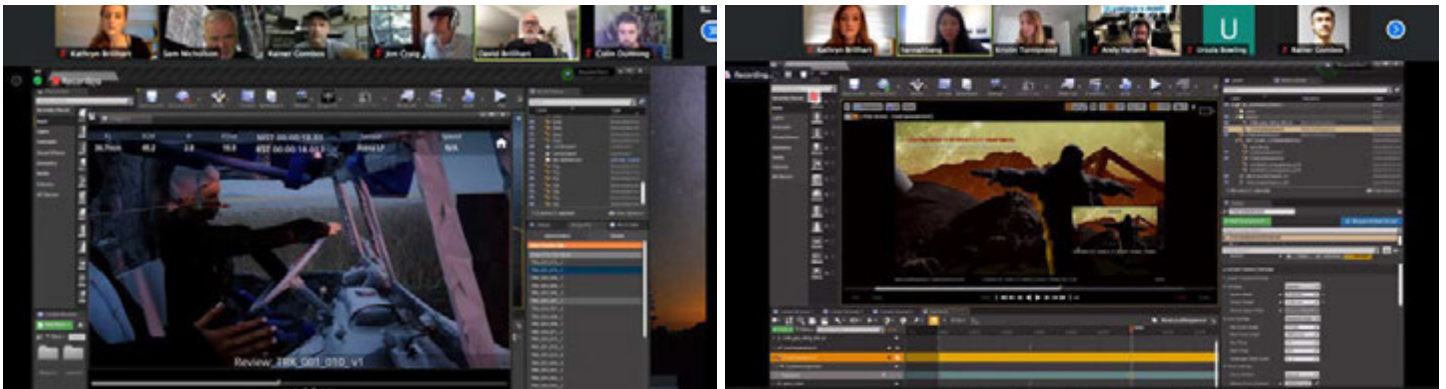

Because we knew that our directors would like to have flexibility to manipulate assets and lighting in our environments in real-time on set (during testing and shoot days), we also communicated this to Lux Machina and Stargate Studios whose workflows needed to integrate with our visualization vendors to meet this need. We developed collaborative workflows, custom to each stage and vendor set-up, that allowed us real-time virtual scouting capabilities on set. During production, on-set virtual scouting occurred mainly during our testing phase, however the flexibility to manipulate the virtual environment in real-time made it possible to organically find shots during our shoot days as well. Zoom was highly effective in showing a full-screen share while collaborators (including DP with VCam) were able to be viewed as thumbnails. Product offerings from Sohonet helped to offer an increase in quality and reduce latency for the main screen. Unreal Engine and others are also working on integrated solutions, but it is early days.

On early test days, our VP supervisor was able to use Sketchfab AR tools to place a photogrammetry scanned 3D CG asset of our truck in our physical LED smart stage location so that we could “virtually

scout” a CG asset in the physical world. (This is the inverse of typical previs and techvis workflows.) Using an iPad, our crew was able to view a scale accurate version of our CG truck. As if the iPad was a window into the virtual world, our DP was able to physically walk around the truck and find shots. He could experience the scale and physicality of the truck through the iPad by holding his arms up to the correct height of the window and could foresee physical shooting challenges early on. The actual smart screen wall was also visible in Sketchfab (Figure 4.1, below) AR mode and made it possible for the DP to see our content through the CG truck windows. These in-person sessions were impactful when partnered with remote previs, techvis, and safetyvis sessions because they helped our department heads spatially understand scale and potential physical challenges along the way. The Sketchfab AR tool could be loaded on anyone’s phone as well. This meant that the entire creative team and each department head could spend time visualizing the truck independently without scheduling an in-person team event.

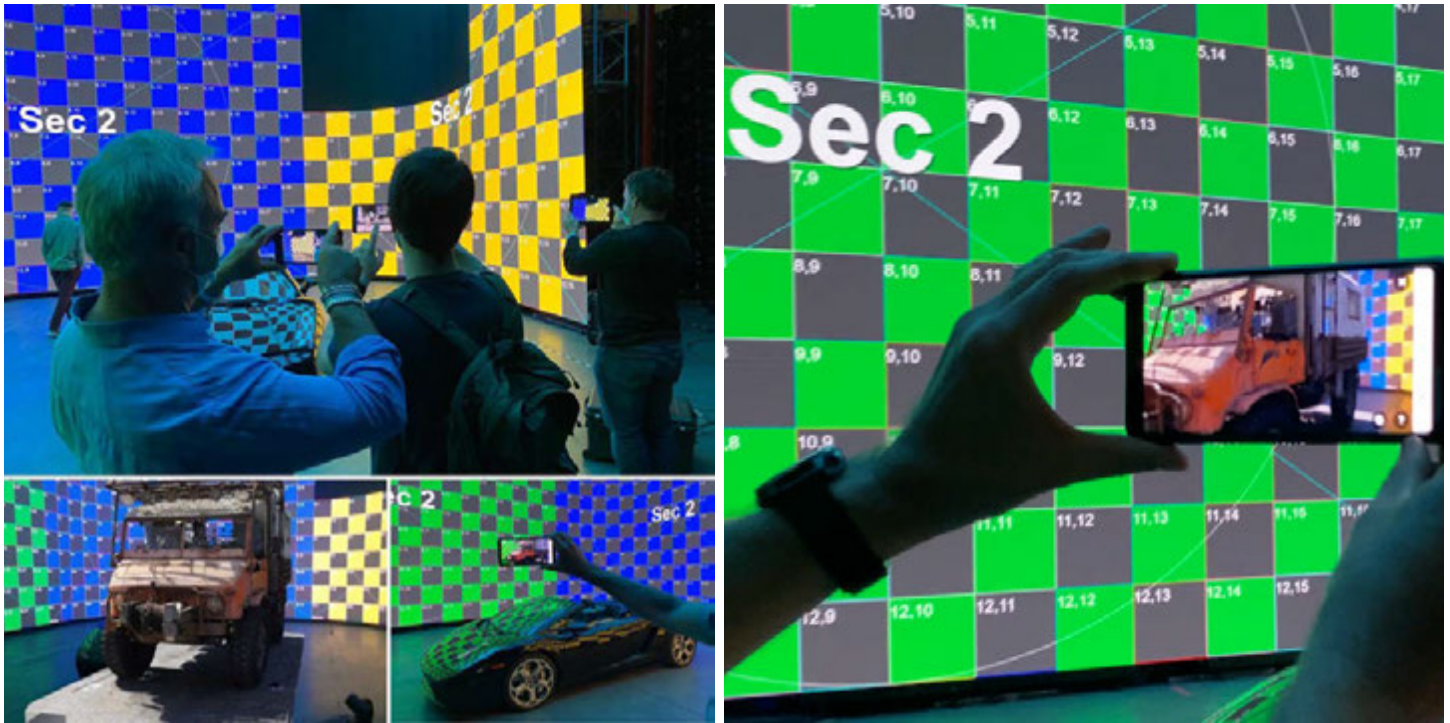

Figure 4.1, Sketchfab AR visualization of LiDAR truck scan

Takeaways:

- To be most effective in pre-production, virtual scouting tools and techniques should be customized to the director or specific department head’s creative needs.
 - For example, a director may prefer to use a VR headset to virtually scout an environment so that they can preview content with technically accurate spatial understanding of scale and placement of assets/characters/camera within a scene. This would require a visualization company to develop unique tools/integrations based on the director’s specific creative requirements. This is a standard request. Requesting multi-user sessions with special tools for each department head is also a standard request that can be made in advance of a visualization session.
 - A DP or director may feel more comfortable operating a shoulder-mounted or iPad-driven virtual camera rig to explore a virtual environment.
 - It is a standard request for actors to participate in a virtual scout in some cases when blocking a scene is necessary.
- The use of real-time integrated performance capture is possible and can help key department heads visualize successes and challenges early in the pre-production phase.

- To be most effective in production, virtual scouting tools and techniques should be customized to the needs of the VP supervisor, DP, and production designer (or other key department heads applicable) so that they are able to execute the director’s vision to the best of their ability and as efficiently as possible.
 - On set, it is important to note that the process of “virtual scouting” should occur during integrated scripted test days intermittently during the pre-production process until the final execution on shoot days to ensure the tools that are being developed work properly. Producers need to schedule a clear “Final Approval” date in their virtual scouting plan to ensure that department heads have time to assess the director’s final creative decisions and finalize their technical strategy to achieve the director’s vision based on these creative decisions.
 - During shoot days, the virtual scouting tools can be used to make last minute adjustments - but the terminology to describe these changes would then be described as “Creative Changes Made by the Director.”
- Photogrammetry workflows can be incorporated into virtual scouting workflows and combined with new technology to create unique mixed reality visualization experiences that not only bring groups together around a central vision, but also allow independent exploration and creative processes to thrive.
- Virtual scouting tools and techniques that are used in pre-production can and should be integrated with the tools and techniques used to operate the final smart stage. If used as a bridge for tool development on a virtual production project, the metamorphosis from virtual scouting to the refinement of a creative vision on set can be a non-destructive one. It also ensures the budget and resources set aside for developing these tools are being maximized.

Virtual Art Department (VAD)

The Virtual Art Department (VAD) is in the process of being defined within our industry. Think of the VAD as a transitional team bridging the work of a more traditional art department and a regular previs department via the advent of real-time animation.

The work of a traditional art department is generally focused on visual development and pre-production. The VAD is no different in terms of emphasis. The main difference is the VAD is often tasked with delivering complete camera-ready assets for production as opposed to handing off to set building or visual effects departments. With this in mind, the work of the VAD may be more involved and intensive compared to a more traditional workflow, but will ultimately handle a larger share of final imagery. [Virtual Production Field Guide, 2019]

[PER HALON ENTERTAINMENT]

- **Describe the role of the Virtual Art Department as it relates to delivering a game engine project for final pixel for display on LED walls for in-camera effects.**
 - The Virtual Art Department is responsible for making sure the environment is optimized for playback on the LED wall.

[PER HALON ENTERTAINMENT]

- **What is the VAD (Virtual Art Department) as relates to visualization?**
 - VAD is a digital-only version of the Art Department.
- **Describe the role of the Virtual Art Department as it relates to visualization.**
 - The role of the Virtual Art Department is to create digitally optimized assets to be used for visualization.

On *Ripple Effect*, a majority of our assets and environments were purchased from UE Marketplace and

TurboSquid. Due to limited time during our pre-production phase, we were not able to design and build custom photoreal assets. As the physical sets and assets were also not built well in advance of the shoot, we were only able to apply photogrammetry techniques to specific assets.

VAD Team & Skill Sets

Supervisor

Lead/Senior Environment Artist (Crew Scales with scope of project)

Lighting Artist

TD

[PER HALON ENTERTAINMENT as relates to visualization]

- **How do VAD Teams typically collaborate with physical production? **Describing their specific company pipeline****
 - VAD collaborates within the Art Department in the following ways:
 - They work closely with the Production Designer to ensure the assets maintain visual integrity.
 - They work with set decorator to ensure the transition from physical set to virtual set is as seamless as possible.
 - They work with construction to get digital scans/photogrammetry of set builds or inform build specs.
 - VAD collaborates outside of the Art Department in the following ways:
 - They work with the Camera Department to make sure that their set covers the frustum and they can dress elements to the camera.
 - They work with Grip and Lighting to address any adjustments that are needed to the virtual environment in order to match lighting, gobos, etc, found in the practical sets.
 - VAD Collaborates with VFX departments in the following ways:
 - Maintaining delivery and shooting schedule.
 - Managing deliverable(s).

On *Ripple Effect*, Halon only interfaced with physical production during our Test and Shoot Days. Halon was 100% remote except for one physical test day on August 6th. The lead visualization supervisor was able to visit the set and meet our production designer, DP, and directors in person.

During Previs & Techvis Halon's VAD team worked remotely with our directors, DP, and production designer to build the environments based on key concept art, pre-purchased megascan assets, and our DP's shot list.

Key Info to Include for VAD Scope of Work [from Physical Production]

[PER HALON ENTERTAINMENT]

- **What key information does a VAD department need from physical production to determine final asset/environment resolution for display on LED walls for in-camera effects?**
 - Key information that VAD needs includes but is not limited to:
 - LED wall dimensions
 - Frustum resolution
 - Simulation requirements
 - Size of set build
 - Tool compatibility with LED wall vendor
 - Latency between camera movement and LED wall update

- Required assets and photogrammetry
- Camera specifications
 - Resolution
 - Dimension
- Delivery aspect ratio
- Frame rate
- Physical Lens package
- Turnover procedure
- Deadline
- LED wall testing availability
- Production schedule

VAD Pipeline

Purchased Assets for Game Engine

There are online stores that sell high quality, photogrammetry captured, assets that are real-time game engine ready.

Make sure that the assets are compatible with the game engine version you are working in to avoid extra conversion steps.

As we had a rapid schedule on *Ripple Effect*, we sourced our assets from the following asset libraries instead of creating original assets:

- Epic Games, Unreal Engine Marketplace
- Epic Games, Quixel Megascan Library
- TurboSquid

Original Assets for Game Engine

Depending on the type of asset requested, the time and artistry required to create it will vary. If the character, prop, vehicle, or environment exists in the physical world, they can likely be scanned using volumetric capture techniques which can significantly reduce the time it takes to create the original model.

Capturing assets using photogrammetry techniques will require a “delighting” step for use in game engines so that their surfacing and applied materials react properly to real-time interactive lighting.

We used photogrammetry techniques to capture our practical truck and were able to use the reconstructed data throughout our pre-production and production pipeline to centralize the directors and department heads around a common vision for the truck sequence. (See vehicle scanning below.)

In-House Asset Creation VAD Pipeline Steps:

Photogrammetry Capture - High resolution photography taken of an object/landscape/vehicle/creature/human from every angle. The parallax between the images helps software reconstruct the pixel data from each photo into a 3D CG version of the subject.

Data Reconstruction - Using computer software such as RealityCapture or Agisoft, photos taken of a subject can be aligned in 3D space and converted to point cloud data, creating a pixel accurate representation of the subject as a 3D CG asset.

Retopology/Modeling - Using computer software such as Maya, the point cloud data can be

reconstructed as polymesh.

Texture - Substance is a software suite from Adobe through their acquisition of Allegorithmic in 2019, that allows a user to edit and enhance the resolution of textures. Cloning textures to fill in gaps in addition to blending exposure differences help normalize both color and texture. It is also possible to generate color data based off of height, areas of occlusion and curvature. Photoshop is another common software used to add high pass detail to the normals and bump map. Other steps that may occur in this step are texture uprezing and sharpening for an enhanced photoreal look.

Lighting & Shader Development

Lighting and Shader development along with high resolution textures will get next to photoreal results. Understanding how light and asset surface attributes like roughness and metallicness work in tandem are critical for achieving realistic results. Real-time ray tracing is a significant advancement in lighting and shader development in Unreal Engine that models real-world photonic interactions.

De-Lighting

Removing shadows is an important step for preparing assets for interactive lighting in Unreal Engine. Agisoft Delighter can be used to delight. It analyzes geometry and will respond to custom keys made by the user that identify shadows, highlights, and normal color. Once data has been input, Agisoft will remove the shadows. Delighting allows the pure color of each asset to interact with real-time lighting in a game engine.

Integrate Unreal Engine

Once the assets have been modeled/textured and/or processed and reconstructed, they can be brought into the Unreal Engine. Maps are connected into custom built materials that gives us even more control over the tone, look, and feel of our environment. The material gives us the ability to add detail where needed and visualize how assets will be affected by light.

Optimize for Efficiency

Once in the engine, there are a number of ways to optimize geometry and textures. In order to maintain visual fidelity and keep real-time playback becomes a delicate dance. Level of detail (LOD) can be used to adjust the amount of triangles and resolution of texture needed based on distance from the camera. Analysing the level of detail helps a VAD team to reduce the amount of draw calls where computing time is lost.

In many cases, it may be more efficient and cost effective to hire a vendor or individual that specializes in photogrammetry to provide deliverables to your VAD team.

Visualization VAD Pipeline

[PER HALON ENTERTAINMENT]Describing their specific company pipeline****

- **Describe the VAD pipeline for visualization services. Please include a description of each step and software used.**
 - VAD acquires assets from the client (as appropriate) through various sources: Hard Drives, Google Drive, Dropbox, Aspera, Box, etc. If the client doesn't have any assets, this step is skipped.
 - They create optimized assets, or optimize the preexisting assets, using various 3D applications such as Maya, Blender, Substance Designer, Substance Painter, Megascans, etc.
 - When an asset is ready to be passed to the next step in the pipeline, this can be achieved through a variety of services such as Perforce Helix Core, Hard Drives, Google Drive, Dropbox, Aspera, Box, etc. But when everyone uses the same version control tool, it can streamline

collaboration and centralize digital asset management.

- Is this the same pipeline/process/workflow as a VAD taking an environment to final pixel for display on LED walls for in-camera effects?
 - The pipeline is the same for display on an LED wall. The workflow will be determined by the specific needs of the production.

Final Pixel VAD Pipeline

[PER HALON ENTERTAINMENT] **Describing their specific company pipeline**

- **Describe the VAD pipeline used to create final pixel quality environments for display on LED walls for in-camera effects. Please include a description of each step and software used.**
 - VAD acquires assets or Look Dev from the client through various sources: Hard Drives, Google Drive, Dropbox, Aspera, Box, etc. If the client doesn't have any assets, this step is skipped.
 - VAD creates optimized assets, or optimizes pre existing assets, to LED wall specifications using various 3D applications such as Maya, Blender, Substance Designer, Substance Painter, Megascans, etc.
 - When an asset is ready to be used for filming, it is transferred to the LED wall team through a variety of services such as Perforce, Hard Drives, Google Drive, Dropbox, Aspera, Box, etc.

Volumetric Capture

Volumetric Capture techniques are essential for uniting physical and virtual worlds. Data captured can be used to build digital environments, visualization, visual effects reference, asset archiving and more.

Photogrammetry

With enough lead time during pre-production, production designers can use photogrammetry techniques to quickly iterate and transform their physical creations into digital re-creations. These assets are then available for use in production as practical and digital set pieces, allowing more flexibility with seam integration and minor asset adjustments on set.

Human Scanning

Human and creature scanning is important reference data to have for post visual effects teams. On *Ripple Effect*, we used handheld photogrammetry of cyborg Ara to capture her likeness in case further adjustments needed to be made to her character in post. Ideally, our scans would have taken place on the final set in final lighting, however due to limited time on set and limitation on talent interaction with crew zones on set, we chose to set up our photogrammetry shoot on another date. We did not need to rig our character for animation so a neutral t-pose scan was not necessary for this project.

Prop Scanning

Prop scanning during pre-production and production has many advantages. Capturing props early on is useful for a VAD and VFX team for use during previs, techvis, and world building. Capturing props during production is useful for archiving and preserving assets as they were on set in final position and lighting. A studio or project can use scanning techniques to capture and preserve sets for reverence in the future.

Vehicle Scanning

Due to the fast paced schedule on *Ripple Effect*, we were only able to access our hero truck vehicle outdoors at its rental facility. Our VP Supervisor visited the rental facility to take photos of the truck in order to reconstruct the images into a 3D CG asset (photogrammetry) that would be used throughout our

pipeline.

CG Truck used for Virtual Scouting via Mixed Reality Sketchfab Platform, CG asset in Previs to plan shots, Animated CG asset during Techvis to plan shot, and Animated Truck in final Environment during shoot to be captured in-camera.

SET / LOCATION SCANNING

LIDAR Scanning

Light Detection and Ranging (LiDAR) is often used to scan locations in combination with photogrammetry because the scans capture scale and GPS accurate geometry. LiDAR scanning technology has recently made available to the masses via Apple's iPad Pro, and the just-released iPhone 12 Pro.



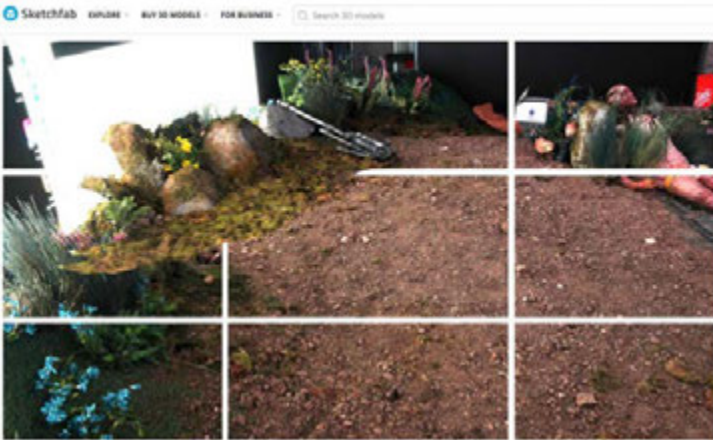

ITERATIVE PHOTOGRAMMETRY

With enough lead time during pre-production, production designers could use photogrammetry techniques to quickly iterate and transform their physical creations into digital re-creations. These assets are then available for use in production as practical and digital set pieces, allowing more flexibility with seam integration and minor asset adjustments on set.



Adding Virtual Entities

(e.g. actors, animals, etc., in addition to what is being captured with real actors)

One of our key test cases that spanned from previs to final in-camera content, was the choice to include an animated CG Truck in our Battlefield environment. (See figure 4.1, above.) Early in our pre-production phase, our VP Supervisor used photogrammetry techniques to scan our truck and reconstruct it as a CG asset. We were able to use our CG Truck asset during mixed reality virtual scouting, as a previs asset, a techvis asset, as a final asset animated on LED walls during the shoot, and as a final, photoreal fully modeled VFX asset in post to create fully CG constructed shot featuring a close up of the exterior and wheels driving down the road. This collaboration and non-destructive workflow included our ETC VP Team, Halon Entertainment, Lux Machina, our ETC Post VFX Team, and FuseFX.

In addition to the truck, our ETC Team also used photogrammetry techniques to scan and reconstruct; two prop guns, the Ara character in final “dead cyborg” position, and portions of the practical set.

During Truck Scene previs sessions with ICVR, they used Xsens suits to provide performance capture driven table read sessions with our directors and actors. The ICVR team would wear Xsens suits and act out actions as directed. The creative team was able to quickly apply the recorded performance capture to characters in our Unreal Engine previs scenes to calculate accurate performance timings and give our Directors a clearer sense of emotion during the progression of the scene.

Timing actor performance in advance of our shoot was critical to our workflow because it informed the speed of the vehicle, the distance of terrain the truck would travel, and how long the content would need to play behind talent to minimize content re-set times and loop stitches.

During later remote sessions, our DP was able to open ICVR's Unreal Engine project file and use Glassbox DragonFly virtual camera iPad system to frame shots of the truck with pre-recorded actor performances applied to CG characters. During Zoom recorded remote sessions with our directors, he was able to demo different lenses and framing choices during previs and techvis prior to the shoot (see figure "x", below).

The ability to visualize shots, scenes, and sequences early in the process helped our directors determine what creative was working and what was not working before stepping foot on set. The extra preparation was also important for our Director who was planning to work remotely during shoot days. It ensured that she and our DP had a game plan and a clear priority list going into physical production.

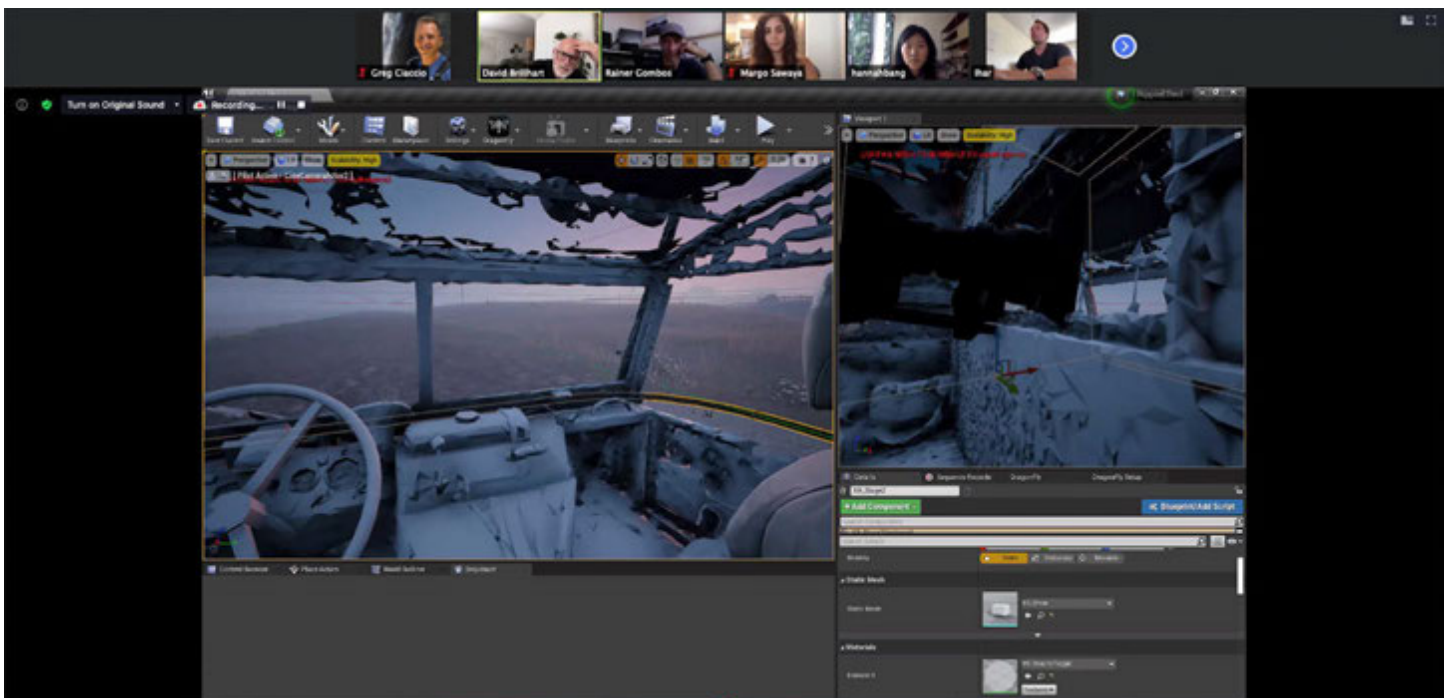

Figure "x", previs session with DP operating virtual camera, actor in Xsens mocap suit and our creative team providing direction to our ICVR team providing imagery

Asset Optimization Process

[PER HALON ENTERTAINMENT]

- What are key factors that could potentially cause changes in asset resolution and optimization throughout the process?
 - Amount of camera and asset motion required
 - Complexity of animation

- Number of assets required in a given shot
- Amount of flexibility required for shoot day adjustment
- Environmental simulation requirements
- Perception of asset quality on LED wall
- Production schedule updates
- **Describe the optimization process.**
 - Reduce mesh geometry while maintaining visual integrity
 - Reduce texture resolution while maintaining visual integrity
 - Reduce draw calls
 - Combine geometry
 - Add/remove tessellation
 - Reduce scope of world based on camera angles
 - Adjust culling distances
 - Replace geometry with cards based on camera angles and movements
 - Replace geometry with procedurally generated material
- **How does optimization relate to playback during physical production?**
 - Optimization determines the framerate at which the environment will playback on the LED wall
 - Improperly optimized assets can add additional lag between the camera system and the wall and may also lead to LED wall system crash during playback.

VAD for Visualization

[PER HALON ENTERTAINMENT]

- **What is the VAD (Virtual Art Department)?**
 - VAD is a digital-only version of the Art Department.
- **Describe the role of the Virtual Art Department as it relates to visualization.**
 - The role of the Virtual Art Department is to create digitally optimized assets to be used for visualization.
- **Are VAD teams able to remotely collaborate? If so, please describe the workflows and tools used.**
 - Perforce Helix Core is the version control system used by game development teams. It can help Virtual Art Department (VAD) contributors to version all their digital assets, not just code.
 - Multi-User Editing in Unreal allows VAD artists to simultaneously edit within the same project.
- **How much scheduled lead time does a VAD team need to prep for a Virtual Location Scout?**
 - The lead time required for the scout depends on the complexity of the scout. This could be as little as one hour or may require multiple days.

VAD for Final Pixel

VAD Deliverables for Smart Stage [Visualization Company Delivers Direct to LED Wall]

Although creative will vary by project causing specific requirements for VAD teams to differ, the following best practices should be considered as a baseline standard:

- Establish the level of flexibility and real-time interactivity that will be provided on set.
- Establish the level of on-set participation the VAD will play on set.
- Make sure virtual content is designed to “end” at the plane of the physical LED wall.
- Work with the client side CG/Real-time Supervisor to ensure that interactive set-ups in the game

engine are set-up properly and cleanly organized (for manipulation on set)

- Remove “hidden” CG lights
- CG Lighting needs to be virtually setup to match the DP’s direction for how light is motivated on set - i.e. Setting up the Sky - The sky should be constructed with logic the DP and/or VP or VFX Supervisor will understand. We experienced challenges on set at both XR and Lux Machina when VAD vendors set up the sky using cards that globally affected the color of the environments. At Lux Machina this posed a huge issue because we needed the most flexibility to make changes on set. Halon had designed the sky using an HDRI as the main lighting source which locked us into the position of the sun/key light. They applied another layer of stars and galaxy to match the Director’s vision which created a tint (global gelled lighting set-up). We found through the testing phase that engaging a lighting TD is an essential position to provide additional consult and insight to bridge the DP’s physical production understanding of virtual production lighting with UE and LED walls.

VAD Deliverables for VFX Team [from a Visualization Company]

VAD & Final Pixel Quality

[PER HALON ENTERTAINMENT]

- **Define final pixel.**
 - An image that appears on an LED wall that will be filmed by a practical camera.
 - Image quality is determined by production and informed by the LED wall specifications.
- **What factors during physical production affect final pixel quality? Please list as many factors as possible and describe how each affects VAD planning and workflow.**
 - Distance from screen and lens used
 - Informs on physical size of environment and LOD falloff.
 - Camera Choice
 - Sensor size affects depth of field, shutter type (global, rolling) may affect motion artifacts.
 - Shutter speed and angle
 - Should be optimized for LED wall capture.
 - Size of screen
 - Informs on pixel resolution of the environment.
 - Camera framing, focus, depth of field
 - Informs on “readability” of the environment in the background and LOD falloff.
 - Desired camera movement, parallax and force perspective
 - Informs on the viability of virtual set extensions.
 - Moving environments (ex. vehicle windows)
 - Rate of speed and amount of motion blur can inform required image quality and optimization techniques.
 - Camera and Wall relationship
 - Overly fine details in an environment can cause anti-aliasing artifacts.
 - The out-of-focus quality can influence the final pixel quality.
 - LED wall physical dimensions
 - Physical wall size combined with pixel pitch determines the resolution required for the frustum.
 - Can a filmmaker choose to render final pixel shots directly from the game engine?
 - Yes
 - If so, is there any additional post work required?
 - Additional post work would be determined by the needs of the production.

- What scenarios are ideal for displaying VAD content on LED walls for in-camera VFX?
 - Elements of physical production are highly reflective and there would be a high probability of greenscreen spill into the physical set.
 - Physical limitations for practical set build.
- Please also identify any limitations to these workflows.
 - Camera movement is limited based on screen arrangement and subsequent tracking abilities.
 - Camera focus distance is limited based on pixel pitch of LED wall.
- Were any special shooting scenarios created in the techvis phase implemented during physical production?
 - Many of the shots were created in techvis in order to maximize the potential compound movement of camera and actor in relation to the wall. This was implemented during physical production by offsetting the camera and talent from the center of the stage.
- Please describe the workflow developed between Halon and Lux Machina to display VAD content on LED walls for in-camera VFX.
 - Perforce Helix Core offers technology that can quickly sync assets. Halon and Lux Machina utilized Perforce Helix Core to push updates to one another, enhancing collaboration on VAD content for LED walls. Teams could make changes and update in real-time.
- Does a smart stage need to have special equipment to display content provided by a VAD team for display on LED walls for in-camera VFX?
 - There is no additional special equipment required beyond what is needed to operate an LED wall.

Techvis

Techvis is an important process for the Previs shot list to go through - artists take previsualized shots and technically evaluate and plan how to physically achieve the shots during physical production.

Stage Alignment w/ Virtual world - Virtual & Practical Set Alignment

- Where does the virtual world meet the physical plane of the stage? Need to avoid overlap. Overlap of CG world and physical world can cause:
 - Slipping - CG elements to “slip” under the floor plane as the camera horizon line moves on a vertical axis.
 - Scale Issues - CG elements that exist in the space from the physical wall plane and beyond will have incorrect scale and appear to track at incorrect speed.
 - Parallax Issues - When virtual content is designed to exist beyond the plane of the LED wall on the z-axis, parallax and scale issues will occur. The diagram below shows a side view of what it looks like when content extends beyond the LED wall plane. The CG Assets that exist in the virtual world in front of the physical wall plane will move slower than any objects behind them in 3D space. This causes visible parallax issues because CG assets that appear to be on the same plane on set, are actually a series of compressed planes in virtual space. It makes objects that appear to be on the same plane look like they are moving at different speeds in relation to the camera. This creates an exaggerated amount of parallax for all assets that exist beyond the wall plane and also makes closer assets look much larger. You could find your team adjusting the scale of assets that can cause issues in post. To avoid this, the CG environment needs to be designed to stop/end at the physical set wall plane in game engine.
- How this impacted us on set:
 - Truck Scenes: Matching the virtual set with a physical ground plane was not required for

these scenes. Grasses and flower assets placed near the screen wall plane were removed from the UE scene during test days to avoid scale issues. We used real physical grass measured at 12"-18" tall to measure grasses and plant life on screen.

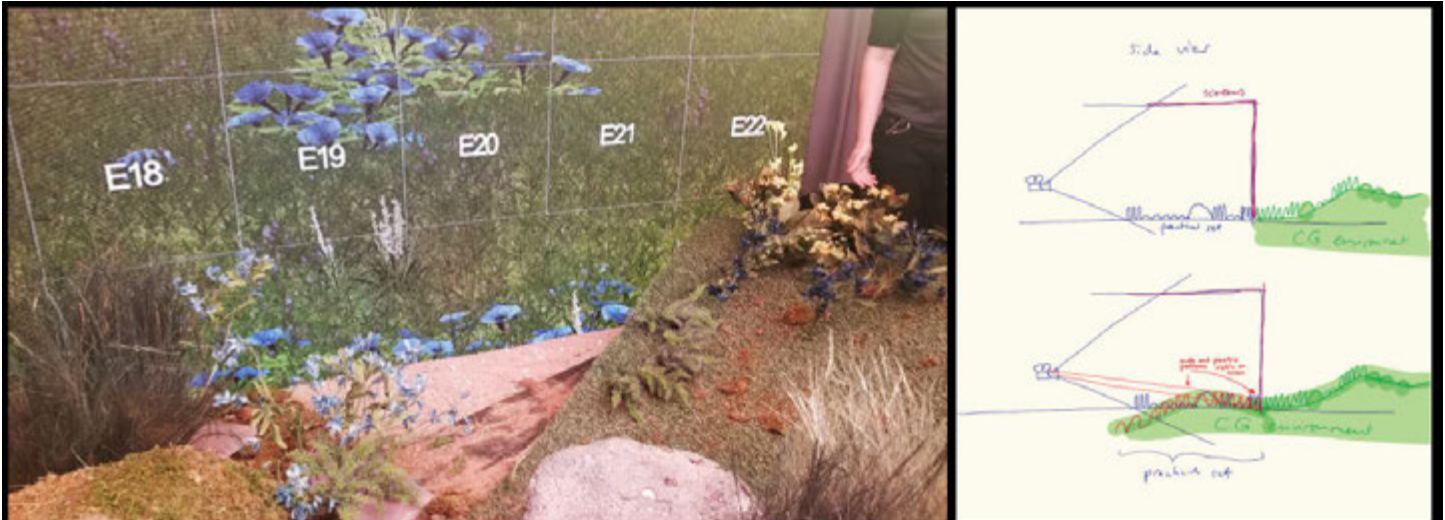

The virtual environment needs to be designed to “stop” at the LED wall plane to avoid compressing any FG environment elements. If FG elements go past the LED plane, the content appears to slip under the practical set, have exaggerated scale issues, parallax speed inconsistencies, and tracking issues.

Solving “Double” De-Focus

(See Case Study 01)

Designing Shots for Custom LED Wall Configurations & Smart Screens

Each of these images represent a step in our process that builds on each other to create an in-camera effects shot. It was important to spend our testing days sharing successes and challenges with our AD at various stages in the process so that they could help anticipate how to use time on set most efficiently.

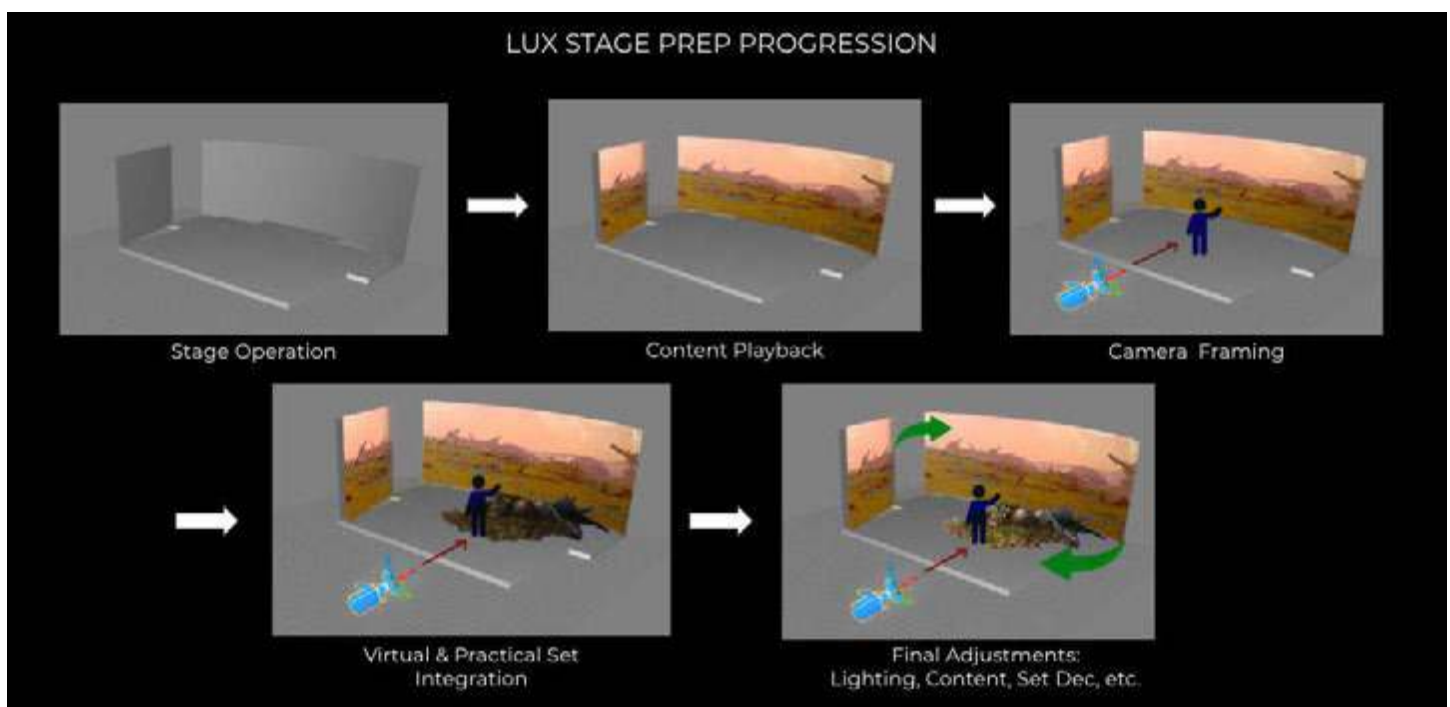

All of these steps occur between techvis and the final shoot.

Safetyvis

Create Production Plans Using Game Engine Insight

- Create plans for physical production leveraging previsualization and additional data/insights from the game engine prep.
- Identify opportunities to optimize real-time technologies to reduce the iteration time for VFX, and give the ability to put together better approximations of the final shots earlier.
- Identify how game engine can be used for safety visualization to create reports/overviews tracking cast/crew movement on set for review of COVID-19 safety coordinator.
 - How much more time consuming would it be to set this up and use it?
 - How much better would the experience be in planning than trying to do it in something like Excel? What are the benefits and limitations?
 - Can you give these plans to the 1st AD and the Set Designer to help them with building the set?

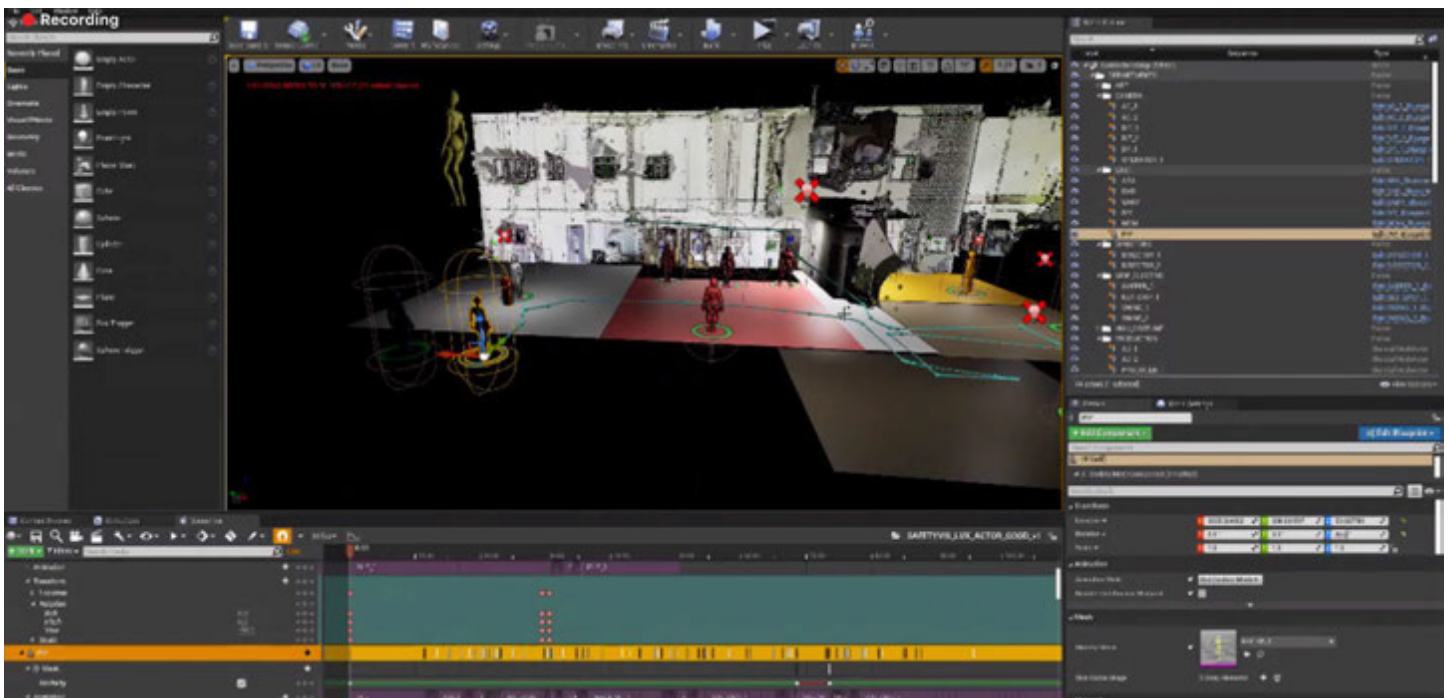

REVIEW WORKFLOW

It is important to establish a review and approval process at the beginning of a project to ensure that decisions are made at the right time, by the appropriate individuals, and to make sure creative continues to move through the production pipeline.

In post visual effects, this is common practice, however it may be new to productions integrating these workflows into early stages of a project.

Using centralized databases such as Shotgun Software, ftrack, or 5th Kind (to name only a few) can help productions store, manage, and track projects. When everyone on a team can access relevant information, notes, and visible approval statuses, important communication can be streamlined. Without a database

that acts as a communication center and interactive place to store important data, it can get lost or forgotten if it lives separated in emails, Slack notifications, and Zoom calls. Additionally, building this infrastructure into a virtual production project helps keep all important project information organized so that it can be easily exported to vendors during production in-camera effects process as well as in post. Another benefit of these platforms is that they are highly secure.

On *Ripple Effect*, we had access to many professional tools including ftrack and 5th Kind Core. With only eight weeks scheduled until production and limited volunteer production support, we did not have adequate time to set up professional databases with automated tools. Without automation and pipeline integration, databases can be cumbersome to organize and manage.

We built initial shot lists and asset lists in Google Sheets and shared these with our team. We were able to edit them remotely and track changes as we went. Our schedule was so tight that we reviewed assets and creative daily on Zoom calls with directors. Our Director of Virtual Production, World Building Consultant, and Digital Asset Coordinator took notes and organize approvals and daily decisions via email and Slack threads. In the short term, this process worked well for our team, however it created a lot of manual work for our Digital Asset Coordinator who worked behind the scenes organizing all assets and notes in ftrack and 5th Kind Core.

Our VP Supervisor had extensive background in visual effects and took lead reviewing CG assets as well as shot design with the creative team, production designer, and DP. During the review process, the Director of VP acted as a producer and managed notes, approval, and team communication. It would have been ideal to have a CG Supervisor on the team to handle all technical world building, lighting, and asset reviews, instead of including those responsibilities in the role of VP Supervisor. This would have also improved the notes and frequency of our communication with VAD Vendors, allowing more interaction before the shoot.

REAL-TIME

We used Epic Games Unreal Engine multi-player sessions in two ways:

1. We used multi-player sessions connected via separate networks with ICVR during our Previs/Techvis process. Remote Vcam and Performance Cam sessions.
2. We used multi-player sessions connected via the same network on set at XR Stage so that ICVR could drive creative content while Stargate simultaneously pushed the updated content to the LED wall.

Our Production Designer was able to create original designs for VAD and the physical production design team. These designs were adjusted during Previs and Techvis phase as concurrent physical testing occurred at the LED wall stage. This helped the Production Designer connect the design between the virtual and physical world for minimal adjustments on the day of shoot. Photogrammetry reconstructions of the physical set and/or props leading up to and during production were a way the PD could incorporate scale accurate physical props and elements into the virtual world.

1st AD - Able to visualize along with the Directors and department heads from early stages in the project, the AD was able to anticipate shots that required more complicated set-up times in advance. By participating in early physical stage testing, they were able to experience technical challenges and set-up times well in advance of the shoot to better inform our shooting schedule.



Performance Capture



Virtual Camera

INTEGRATION WITH PHYSICAL PRODUCTION PLANNING SYSTEMS

Organize Assets in 5th Kind (Data Asset Management System)

See Review Workflow Above

Organize Assets in ftrack (Production & Management System)

See Review Workflow Above

In the last decade, virtual production projects have typically hired a visualization company such as Halon Entertainment to help the director/producer understand how the creative vision for the project can be executed on set. Visualization is one of the first steps in a Virtual Production Pipeline. They are hired to previs shots, scenes, and edits so that Producers can adjust their budgets early on in the creative process and plan strategically for virtual production (or post VFX) to be integrated into their projects. Hiring a visualization company to provide accurate techvis is a complementary service that is specifically intended to help break down a shoot into specific needs for physical set vs. virtual set. If the same team is hired to complete previs, VAD, techvis and postvis, this is considered the most efficient, non-destructive workflow. Both ICVR and Halon Entertainment offered these services on our project, *Ripple Effect*.

Visualization companies that have an established history working with game engines have had several years to engineer/develop the tools they use. Some companies already provide script supervisor integrations, multiple virtual camera options, multi-user visualization, etc and have integrated these workflows into databases like Shotgun Software. There is a lot of room for improvement for these integrations, however basic integrations do currently exist.

Our COVID safety real-time interactive tools also impacted our ability to integrate safety data and workflows into our production strategy. A visualization company, DigitalFilm Tree used photogrammetry in combination with real-time interactive previs/techvis techniques to create a unique safetyvis visualization

workflow for *Ripple Effect*. The interactive tool validated a path toward inputting international safety data into an architecturally accurate virtual version of a film location, for production to use as a planning tool, either as remote collaboration in game engine, or 2D printable overhead maps for rapid safety planning by production. Because these tools allowed our production team to iterate multiple safety strategies in real-time, they were able to avoid liabilities that may not be possible to visualize otherwise. They were able to train crew remotely on COVID safety standards and predict cost impacts months before the shoot or test days took place. If a team is using a standard project management database such as Shotgun Software, ftrack, etc. these COVID safety cost impacts can be recorded and attached to production plans, workflows, and assets as well.

TESTING CONTENT ON LED WALLS

(See Designing Shots for Custom LED Wall Configurations & Smart Screens Above)

At the end of the day, nothing compares to being on set. New problems to solve will always arise and there will always be details that are not visible during the visualization process that appear during physical testing. Below are photos and descriptions to share a few things we learned during testing that would not have been anticipated otherwise.



Turning on and restarting LED walls takes time. Often screens needed to restart between content changes in Unreal Engine, varying from 5-20min periods of time. Make sure to plan this into both testing and shoot days.

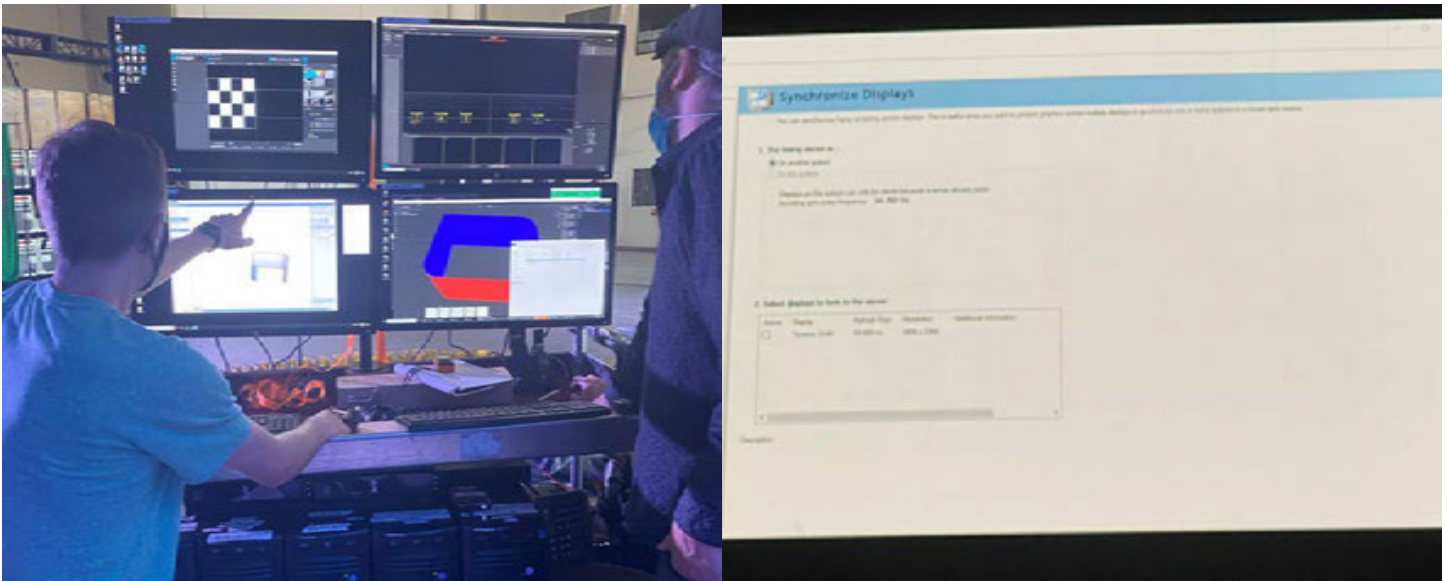

Stage operators need time to power on screens and make sure that they are calibrated for synchronization and set-up for camera tracking.

You can synchronize rendering across displays. This is useful if you want to present graphics across multiple displays and sync one or many systems to a house sync server.

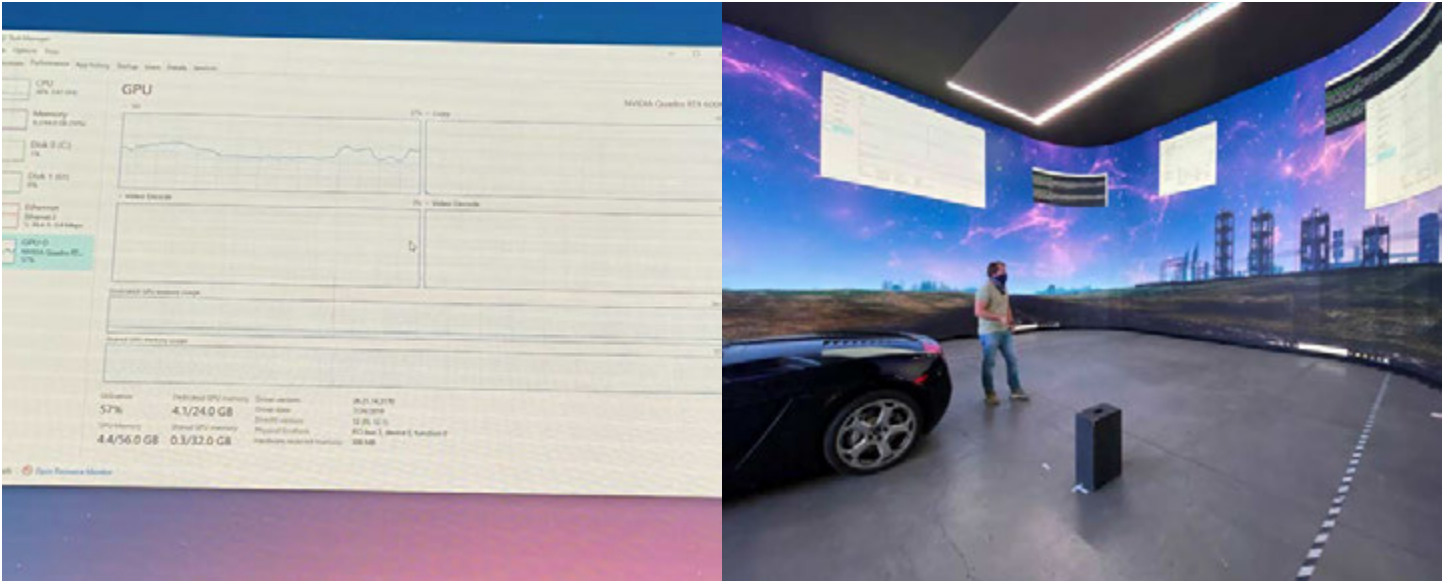

Once content is running on the screens, it's important to monitor GPU statistics to inform further optimization needs of environments and assets in game engine.

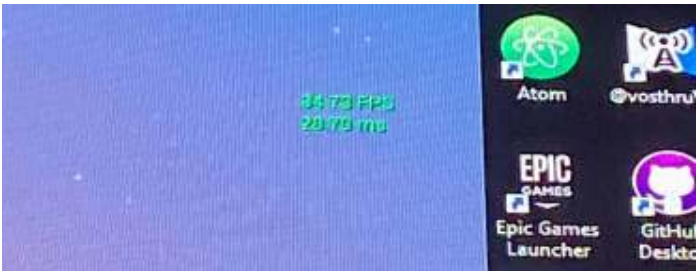

We were able to see the frame rate at which the game engine was running our content on both XR Stage and Lux Machina. This helped us isolate issues with content playback and stage operators.

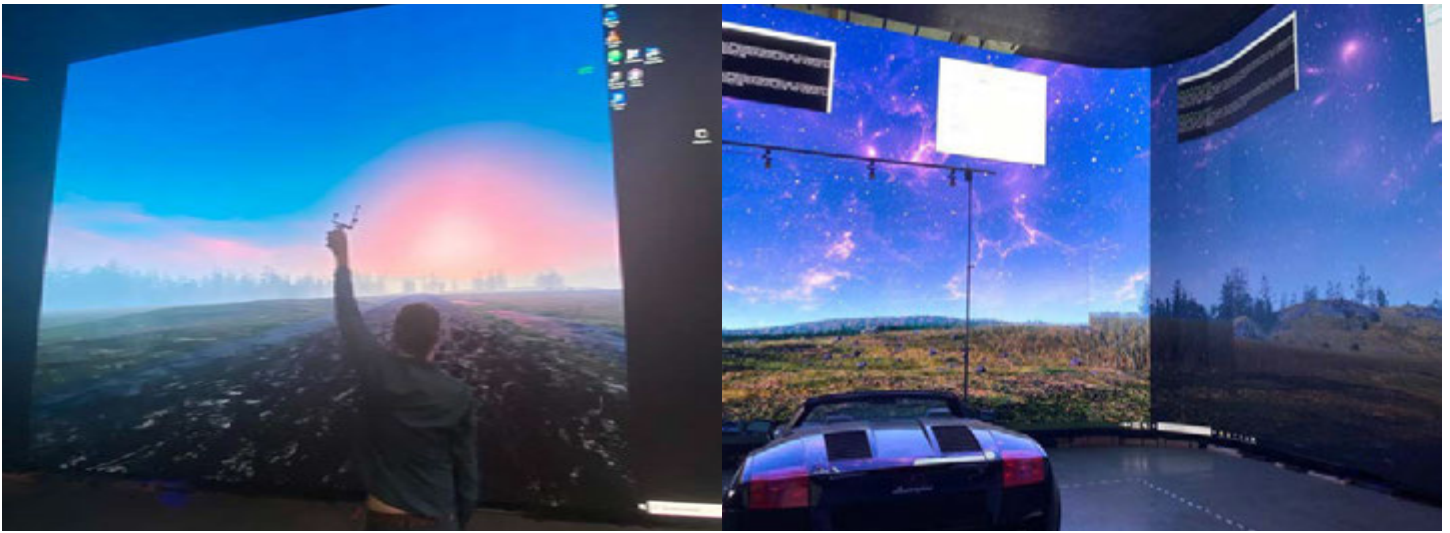

Once camera tracking is set up, it's important to check horizon line and make sure the virtual and physical camera are aligned at the proper neutral position.

If panel seams are visible to your eye - they will also be visible to the camera that could potentially cause post VFX paint out work.

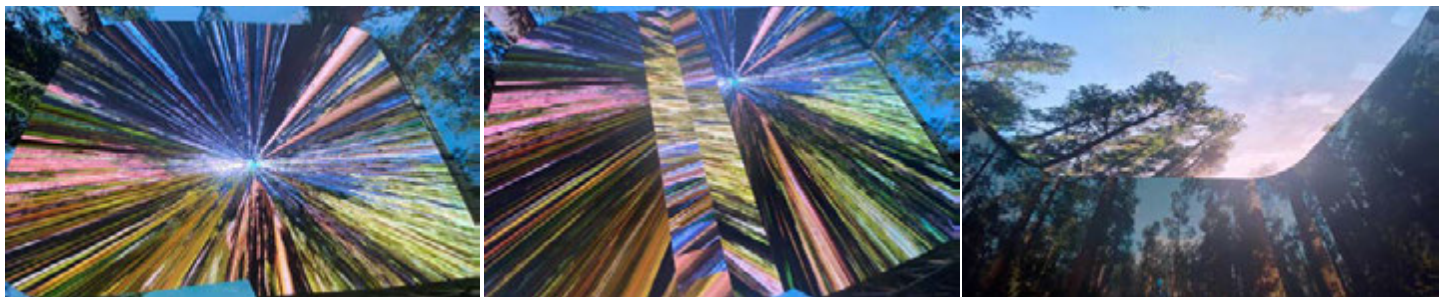

Camera tracking requires calibration on every screen, including the ceiling. Stargate Studios had to mathematically adjust the position of our virtual camera in 3D space for the ceiling to appear correct. One person dialed in the computer system, while another technician moved the physical tracker in physical space to get proper alignment.



When incorporating physical set design, it is important to note that the walls need to be turned on and the content needs to be visible for the art department to build/finalize their set. A camera operator will also need the LED walls turned on to frame their shots. When there are any complications with the walls it has the potential to affect other departments' work.



Camera tracking issues take on many forms. When loading new scenes at Lux Machina, we knew we needed to re-calibrate camera tracking when our scenes looked like this. Once all departments are familiar with the cause of certain issues, the faster they can communicate what they need fixed to a stage operator.



The DP was able to experiment with using shapes as gelled lighting as well as negative fill from certain screens. These intuitive learnings were not possible until test days.

PRODUCTION

Process Per Environment:

Our main focus was to explore real-time game engine workflows in order to design and execute final pixel in-camera visual effects for display on smart stage LED walls.

Using our script's three main locations, we designed and executed virtual background workflows for each.

“Dining Room”



INTERIOR SEQUENCE

“Truck”



VEHICLE SEQUENCE

“Battlefield”



EXTERIOR SEQUENCE

Truck Sequence

VP TEAM ON SET:

ETC VP Director / Producer

ETC VP Supervisor

XR STAGE

STARGATE STUDIOS

ICVR

Translights, greenscreen, and plate photography are commonly used in vehicle scenes as alternatives to shooting on location.

On *Ripple Effect*, we were able to execute and capture footage of our truck that spanned four locations and four different times of day all in one shoot day.



Instead of using greenscreens and composited plate photography in post, our team built full CG environments in advance of the shoot and rendered them in real-time on set during production. Rendering the content in real-time made it possible to tweak lighting, adjust the rotation of the virtual world, and more during the shoot.

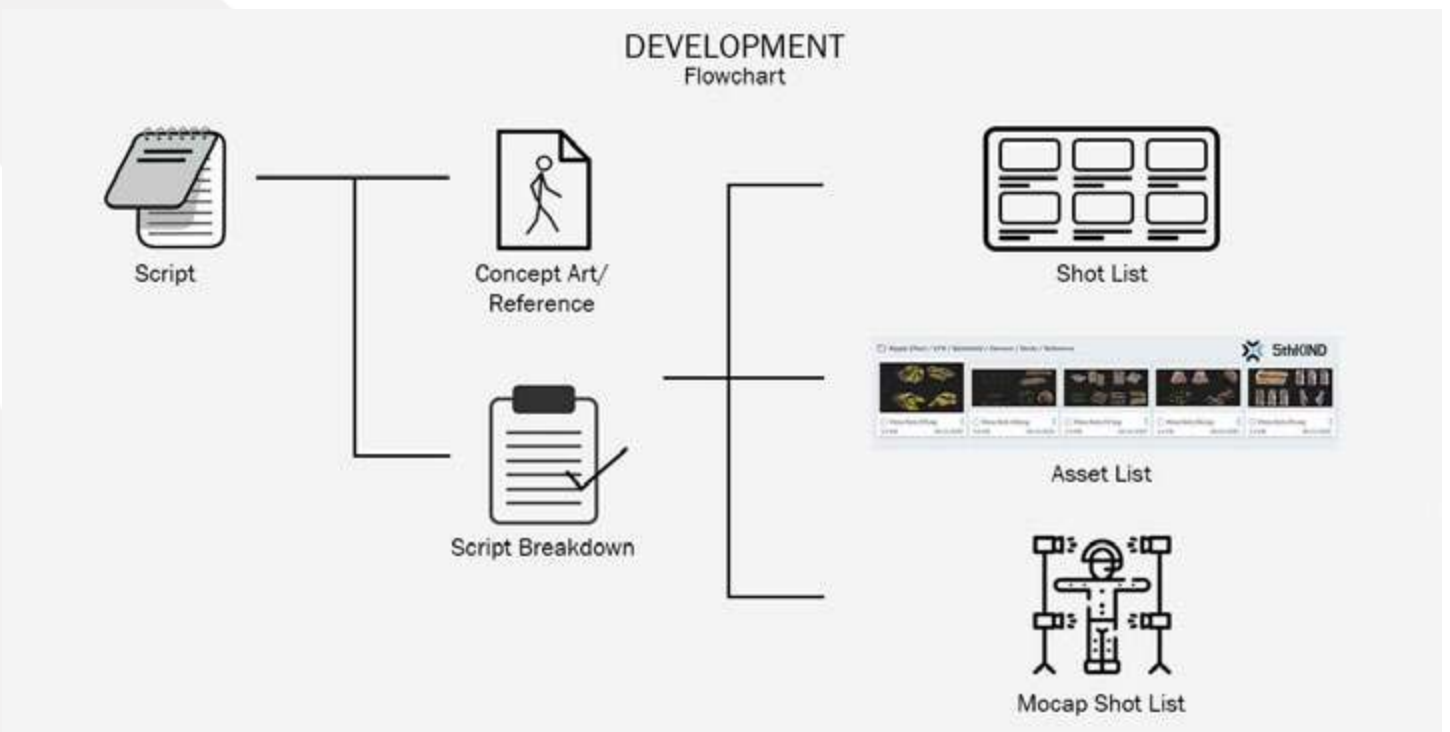

This meant that an extended amount of time and resources were necessary in pre-production to break down our script for in-camera visual effects and to lay out our pipeline.

It was critical that we hired key department heads early in pre-production to participate in the script breakdown and shot design process. Their input determined the complexity of each shot we planned for.

	<ul style="list-style-type: none">● Previs & Techvis● VAD● On-Set Content Playback
	<ul style="list-style-type: none">● On-Set Camera Tracking● On-Set NDisplay Setup● On-Set UE Multi-User Setup
	<ul style="list-style-type: none">● LED Volume Configuration● Facility Operations & Power



ICVR and Stargate Studios were our main vendors for the Truck and Dining Room sequences.

ICVR provided storyboards, previs, techvis, VAD, and on-set content playback, while Stargate Studios mainly contributed on set with camera tracking and LED wall playback.



The directors and world building mentor provided reference images and links to pre-made assets for ICVR's Virtual Art Department (VAD). The VAD team used Epic Games Unreal Engine to build interactive content to play on LED walls surrounding the truck on set.

One of the key elements to a successful visual effects shot is the design.

At the same time a DP is forming shots with the Director and VFX Supervisor, the Production Designer is planning the world of the film. It's critical that these designs are discussed in relation to the shot list in order to economize what areas of the world are constructed in most detail.

Centralized databases like ftrack, Shotgun Software, and 5th Kind can help keep a creative team organized from the development stages all the way through post production.

ICVR's Virtual Art Department (VAD) created the moving scenery that would play behind the truck. These images show the final look of the content.



Scene 01
Final Virtual Content



Scene 03
Final Virtual Content

It's important to note that the content does not look photoreal to the eye, it looks CG. With our short timeline, we knew from the beginning of the project we would have about 3-5 weeks total working with our VAD teams. We set a goal in each sequence to test the level of photoreal production that we might need to budget for in each of these three scenarios. For example, would the content need to be sold as photoreal to our eye, on the LED wall, or through the camera's lens? In this case, we were able to sell a low fidelity, visualization quality, image to the camera and cheat that it was real.

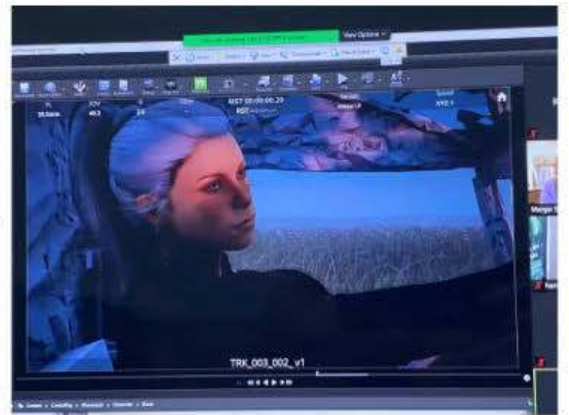
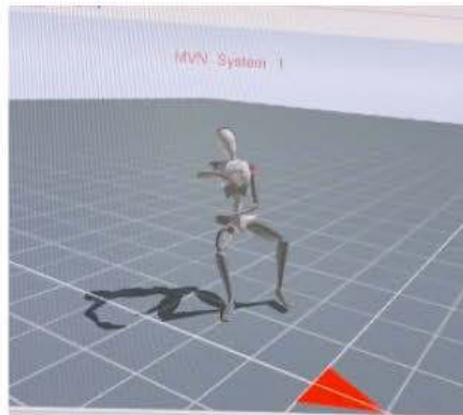

ICVR used real-time performance capture to time dialogue inside the truck to ensure proper speed and distance travelled in our virtual backgrounds.

Making evaluations like this during pre-production can help save resources for shots that require 100% more detail

ICVR used motion capture techniques during our previs phase to identify accurate timing for each scene to ensure we had enough content for playback on set. They also recorded motion for characters inside the truck to help our directors visualize actor performance during each scene.

PHOTOGRAMMETRY



Our VP Supervisor used photogrammetry techniques, taking over 2,000 photos of our picture vehicle, to capture and reconstruct the truck as a CG Asset.

Photogrammetry is an essential virtual production tool for a Production Designer, VAD, and VFX team to match the virtual and physical worlds.

By scanning our truck early in the process, we were able to use a scale accurate version of the asset during all phases of our project. It even made its way into one of the final shots of the film in our Battlefield sequence.

CAMERA TRACKING

Optitrack System



Stargate used OptiTrack System for camera tracking at XR Stage.



DP and Directors discuss logistics for capturing dolly movement across front of truck.



ICVR, Rainer Gombos (VP Supervisor), and Stargate line up the virtual road to the position of the physical vehicle.

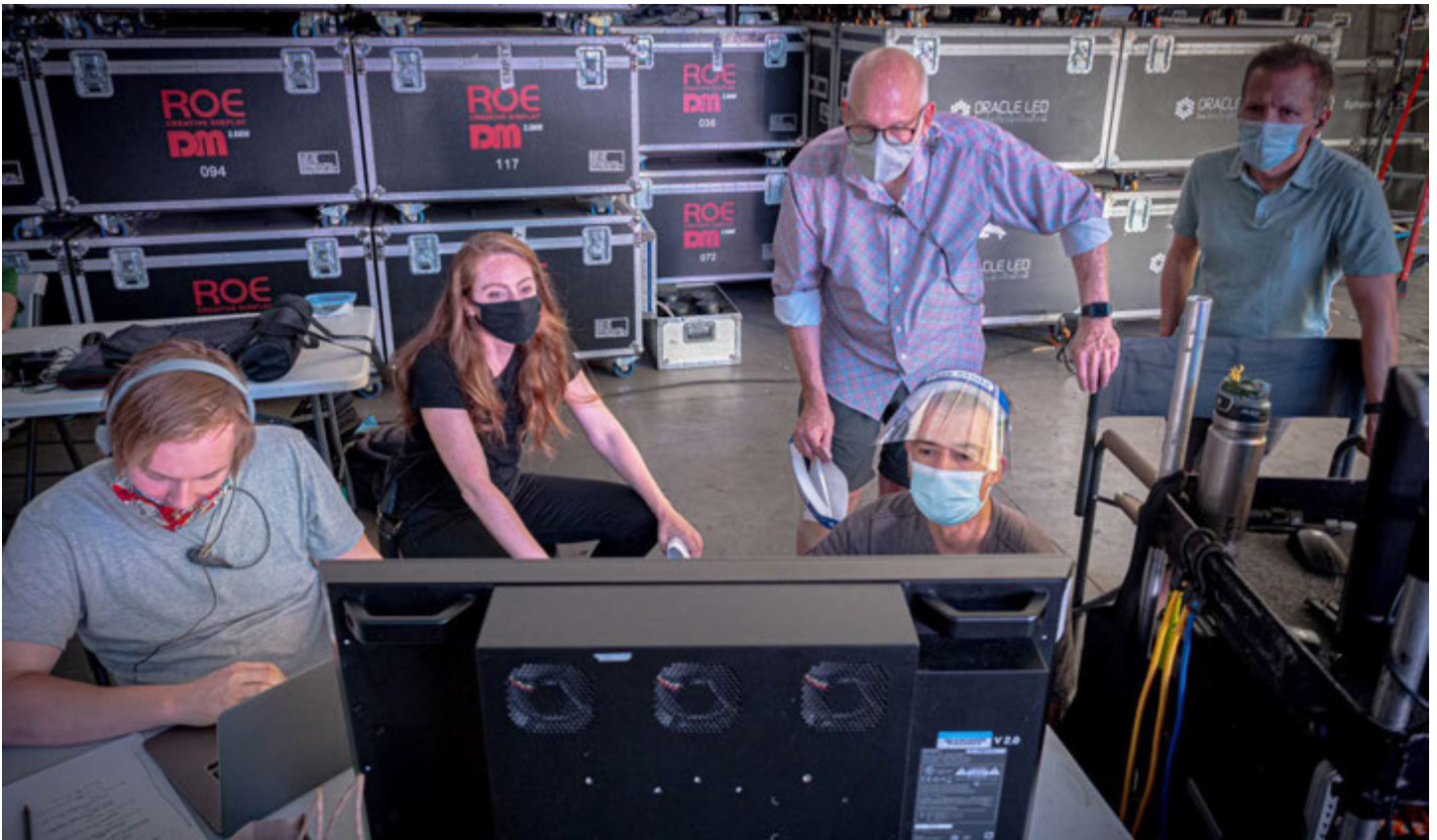

Project leads review in-camera effects live on set. (From left to right - Producer, Director of VP, DP, VP Supervisor, and Head of Production Technology/Head of Post)



Our director, Hanna Bang, makes adjustments to the virtual world with ICVR team and DP in real-time.



Camera Department setting up the camera frame for lighting and VP team.



Director Margo Sawaya directs ICVR as DP and VP team set up for next shot.



Although we did not spin the truck during shots, we did put the truck on GoJax so that it could be rotated between set-ups. We were able to apply movement to the scenes by using Steadicam, dolly, and jib techniques with the physical camera.

Our 1st AC used a remote follow focus system to reduce crew numbers within volume.

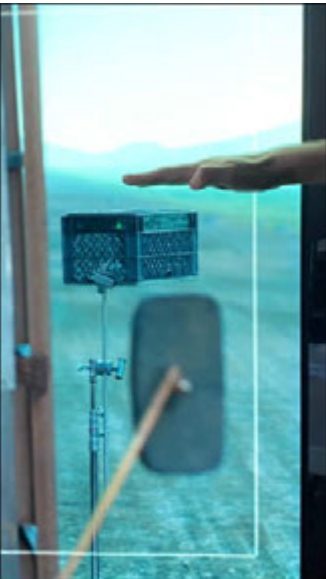

KEY FINDINGS

- Content does not need to be photoreal to the eye, it only needs to sell as photoreal through the lens.
- LED wall acted as an animated translucent with additional flexibility for adjusting lighting, assets, and the orientation of the world in real-time.
- With proper distance from LED walls - it's easy to avoid moire and visible wall curvature.
- Captured beautiful in-camera reflections.

LOGISTICAL CONSIDERATIONS

- SPFX - Wind & Physical Car Movement add complexity
- Double "Depth of Field"
- Virtual Tool Development for Accurate On-Set Supervision

Dining Room Sequence

VP TEAM ON SET:

ETC VP Director/Producer

ETC VP Supervisor

XR STAGE

STARGATE STUDIOS

ICVR

XR STAGE @ Global Trend Pro, Pacoima CA



In many ways, adding an LED translight behind a window is a very straight forward process. However, there are a few considerations that need to be made in advance to reduce complexity.

Do we see the floor? We made the decision early on that we would not see the floor as this might require either a detailed practical set, greenscreen covering the floor, or LED volume to extend on the floor. How do we design the content to show parallax in a believable way? We added a speaker pole to the foreground of the CG content that was high in contrast to the midground and background. How do we hide the seams in the corners of the screen created by the curved LED panels? We added practical set pieces so that the seams would not have to be painted out in post. How do we avoid moiré when the plexiglass window magnifies the LED wall at various perspectives? We were not able to completely eliminate moiré and had to shoot around it as best as possible.

REFERENCE IMAGES



Reference images provided by directors are combined and integrated into the production designer's lookbook for both the practical set and the virtual world outside the window.

We took reference images and designs provided by our directors to concept and build the virtual world that existed outside the window.

CONCEPT ART



To create the world outside the dining room window, ICVR built a virtual world in Epic Games Unreal Engine based on concept art provided by the directors and production designer.

This image shows a painting our VP supervisor created as a placement and lighting guide for the VAD team. Similar to the truck, we held remote previs sessions with ICVR and our DP to find shots using a dragonFly

PREVIS

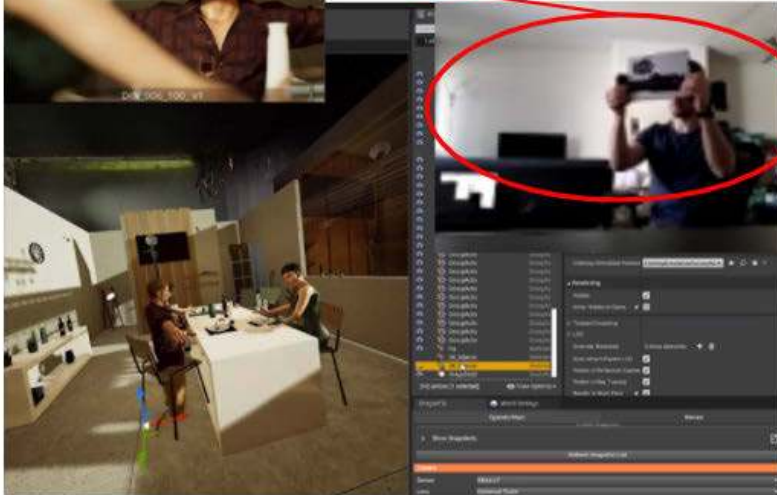

ICVR built a temporary virtual version of the dining room interior set to help the creative team previsualize camera placements, actor blocking, and how the design the virtual environment would play outside the window.

virtual camera iPad system. Building a shot list in our virtual environment helped our virtual production team understand which camera angles the directors planned to use most on set. This was helpful for the AD who had to factor in specific shot timings for our shoot day.

VIRTUAL ENVIRONMENT



Game engines allow for real-time lighting changes and integration on-set. We adjusted the composition of the virtual light poles so that they were much taller-- creating parallax outside the window and a motivated light source.

The techvis process helped us identify how to marry the virtual and physical worlds.

We decided that the speaker poles would become light sources during evening scenes to give the DP the ability to pull the virtual lighting onto the practical set, creating a further sense of realism.

Real-time VAD adjustments on set improved parallax, lighting, and composition.



During our stage testing phase, our team had the flexibility to manipulate virtual assets and refine the composition of the environment in relation to the physical set piece.

Once physical testing on stage begins, there are usually more challenges that arise as all the pieces start coming together.

For example, we learned that darker, high contrast content can make scanlines and banding visible to the camera. The plexiglass magnified and distorted the LED walls at certain angles, causing moire.

We were not able to eliminate either issue and choreographed the Steadicam to avoid them.



ICVR and Stargate Studios calibrates screen synchronization, content playback frame rate, and camera tracking before the Dining Room Set is built.



Dining Room Set construction



The ceiling of the volume was high enough that our gaffer could construct goal posts for lighting the set interior.



Our VP supervisor worked with ICVR to check scale in our virtual world by measuring physical set piece boxes and making matching CG boxes with the same dimensions.



ICVR uses volumetric capture data to align virtual stage with physical stage in Unreal Engine.



Physical props were staged outside the window to cover screen seam lines from certain angles. We were committed to addressing this in-camera instead of requesting paint outs in post VFX.



Our DP had access to color management tools to ensure the images were safe in SD and HDR.



KEY FINDINGS

- Steadicam movement exaggerated moire and banding issues more than using slow dolly movements.
- Real-time adjustments to our virtual assets on set improved the composition of the environment outside the window.

LOGISTICAL CONSIDERATIONS

- Testing Motion in front of LED wall is critical - Applying materials and movement in front of the LED Walls adds complexity and can magnify screen issues.
- Scanlines & Banding - Visible in darker, high contrast imagery
- Crew Reflections - Crew required to wear plastic face shields added unwanted reflections in the window at certain angles.

Battlefield Sequence

VP TEAM ON SET:

ETC VP Director/Producer

ETC VP Supervisor

HALON

LUX MACHINA

TEST STAGE @ LUX MACHINA, Los Angeles CA



One of our main challenges in the Battlefield was matching our practical and virtual sets. We had planned on shooting wider shots of the world which would require more detail overall.

Halon Entertainment and Lux Machina were partnered vendors for this environment.

VENDORS



- Previs & Techvis
- VAD
- Remote Consulting On-Set



- On-Set Content Playback
- On-Set Camera Tracking
- On-Set NDisplay Setup
- LED Volume Configuration



Halon provided previs, techvis, VAD, and 100% remote consultation on set, while Lux Machina provided our LED volume, its operation, and on-set content playback.

REFERENCE

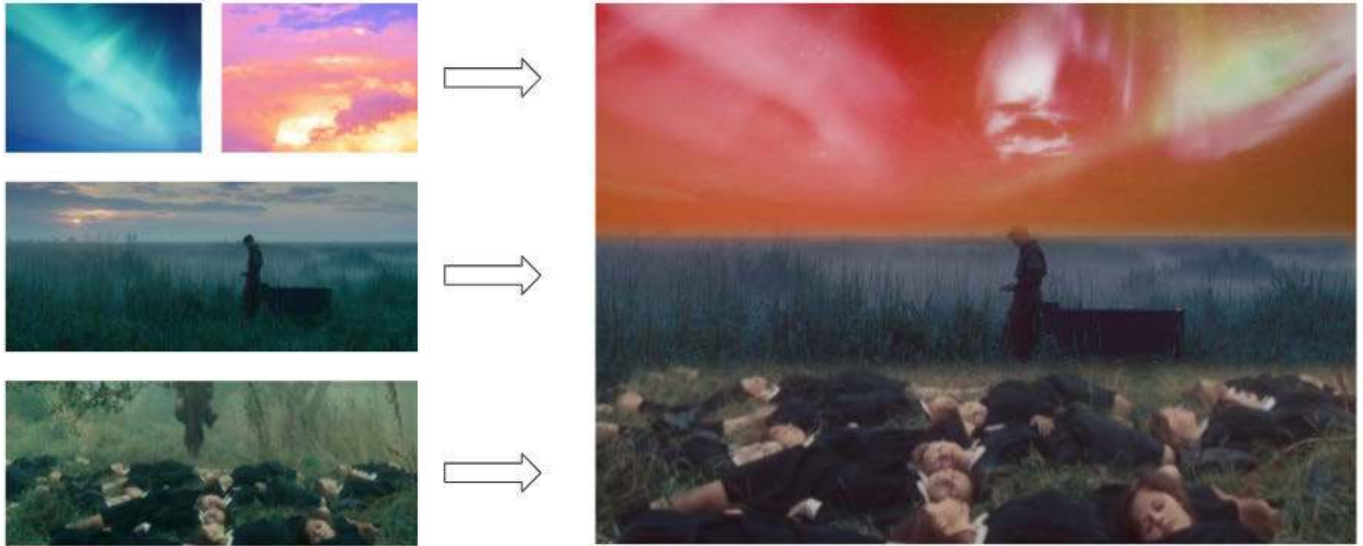

Reference images provided by directors are combined and integrated into the Production Designer's lookbook.

Starting with reference images, our directors began designing the world with Halon's VAD team.

PRODUCTION DESIGN



Our production designer worked with both the virtual and physical art departments to execute her vision.

KEY CONCEPT ART



Having access to scan data of Lux Machina's stage, we were able to design shots visualizing what it would be like to shoot them in the volume.

This was a very important process for our DP. They had to take into account that the camera would stay in the same position and the virtual world would rotate behind the talent. The Lux Machina stage was much smaller than the XR Stage, and its shape dictated how we created content and a shooting plan.

PHYSICAL TESTING PHASE

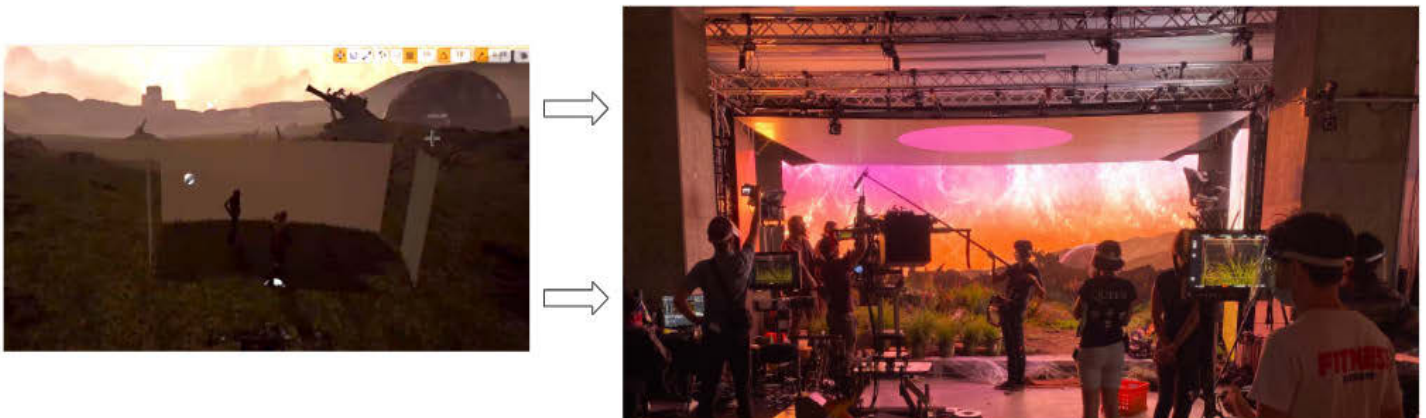

The ETC VP team lead a series of physical test days prior to the shoot to understand any remaining virtual & physical challenges. The more that can be solved in advance of the shoot, the better.

RedSpy emits infrared light which gets reflected back to the camera by reflective markers installed on the ceiling, side walls, or even the floor when used outdoors.

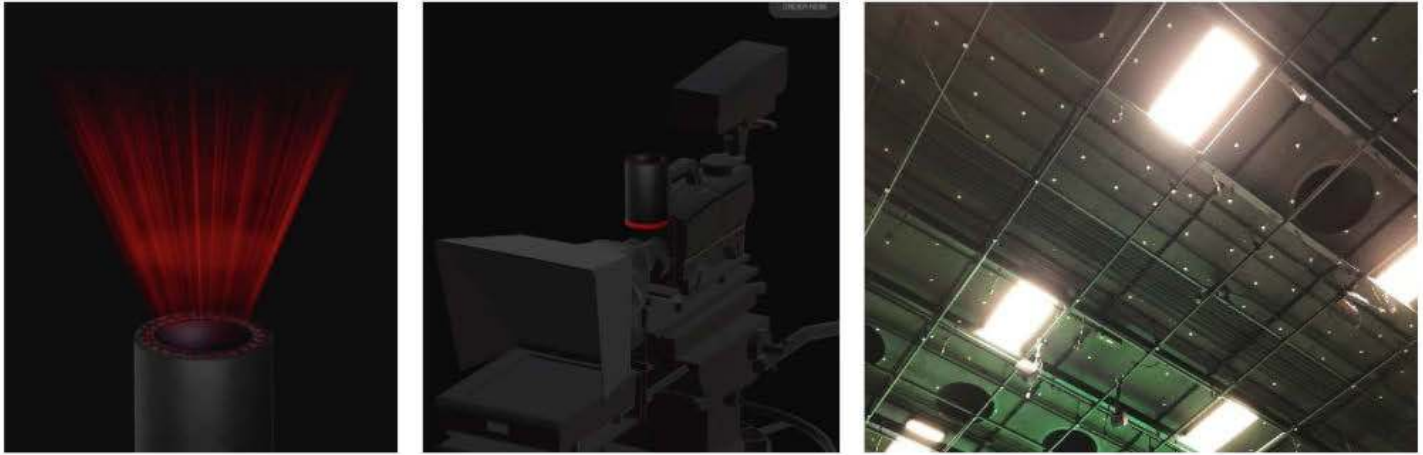

Stype RedSpy Camera Tracking System

ITERATIVE PHOTOGRAMMETRY

The reconstructed photogrammetry of the truck was used as an animated asset on the LED walls for our Battlefield sequence. The truck drives away, out of focus in the background. This was a major success for our project.

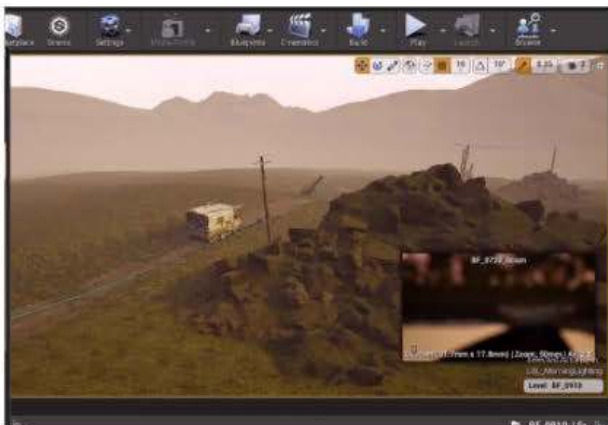

Unreal Engine View



In-Camera View

INSIGHTS:

We used photogrammetry techniques to create a CG version of our truck which appears in our Battlefield environment “driving away” slightly out of focus in a close up focused on Cyborg Ara.

One of our key test cases that spanned from previs to final in-camera content was the choice to include an animated CG truck in our Battlefield environment. Early in our pre-production phase, our VP Supervisor used photogrammetry techniques to scan our truck and reconstruct it as a CG asset. We were able to use our CG truck asset during mixed reality virtual scouting as a previs asset, a techvis asset, as a final asset animated on LED walls during the shoot, and as a final photoreal fully modeled VFX asset in post to create fully CG constructed shot featuring a close up of the exterior and wheels driving down the road. This collaboration and non-destructive workflow included our ETC VP Team, Halon Entertainment, Lux Machina, our ETC Post VFX Team, and FuseFX.

ADDITIONAL INPUT:

Game engine and LED wall tech is rapidly progressing. Game engines were designed (at least initially) for just that – gaming. LED walls have been used for live concert, sporting and other events, which have different requirements. Device profiling and overall system calibration involving lighting sources (LED panels, auxiliary LED/traditional lighting fixtures), cameras, displays and human visual perception is key to developing a flexible and color-accurate pipeline. ACES, for instance, and other color managed workflows, have enabled consistent color experiences across multiple deliverables. DCI projector color calibration provides for an accurate and consistent methodology to ensure that all digital cinema projectors look the same in any theater. Work is being done now to profile these lighting instruments (including LED walls) and calibration methods are being created. Other aspects to be considered are gamma (game engines currently work in 2.2, like animation), panel bit depth, color gamut, spatial resolution (to reduce moire and create more depth), high dynamic range (HDR) and other aspects not listed here which could negatively affect creative choices desired by the production.

PREVIS TO FINAL SHOT

Halon’s team had proprietary tools that allowed us to save all of our creative choices during previs and



techvis phases. This metadata was used on set by Lux Machina stage operators to queue and playback content at the exact orientation planned for specific shots. They were also able to apply exact lens metadata on set as well. This process streamlined our workflow significantly on set.

Color Management is not currently standardized in LED wall workflows. Below are rudimentary tools that were used to check color in the virtual world & physical world through the lens of the camera.

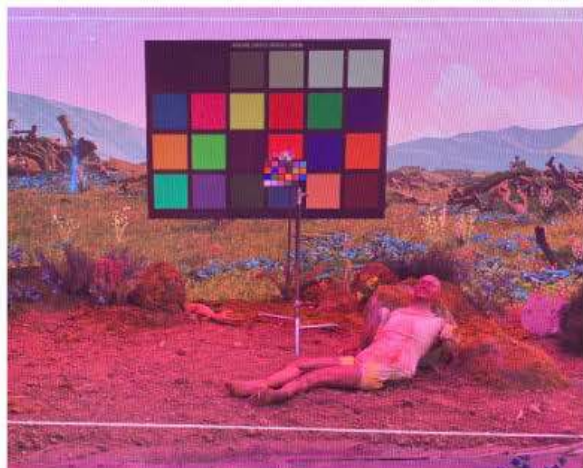

COLOR CHART



LUX CUSTOM COLOR GRID



Our production designer works with Lux Machina technician to move virtual assets to improve shot composition.

Our VP supervisor, Lux Machina technician, and Halon VP supervisor modify the assets and overall composition of the world.



Director of VP works with gaffer and Lux Machina technicians to dial in depth of field and lighting.



Lux Machina screen rebooting during scene change.



KEY FINDINGS

- Adjustments to VAD assets, composition, and lighting were made in real-time. Set aside extra time for this.
- Applying camera tracking markers to the ceiling could help avoid re-calibration during shoot.
- Loading content on LED walls and QCing takes time.
- LED walls are run by computers that can overheat, re-boot, and create power outages.

LOGISTICAL CONSIDERATIONS

- Matching Practical and Virtual Sets
- Physical & Virtual Stage Alignment
- Rotating the virtual world in front of a single camera set-up to capture final shots (Instead of moving camera around talent).

List of General Logistical Considerations:

Rotating Virtual World
Rotating Vehicle
Horizon Line
Proper Scale Digi Assets
Camera Tracking
Color Accuracy
(UE Project to LED Wall to Camera Sensor to Final Output)
SPFX Wind Simulation & Physical Truck Movement
“Double” Depth of Field
Shot Order on Shoot Day
Moire
Motion Blur & Other Post Processing Effects in UE
Screens Overheating & Power Outages
Parallax in Virtual World
Reflections in Windows & Other Surfaces
Scanlines & Banding in Darker, High Contrast Imagery
Steadicam Movement vs. Dolly Movement
Shot Order on Shoot Day
Visible Screen Curvature
NDisplay Set-Up
Matching Practical & Virtual Sets
Rotating Virtual World to Achieve Scene Coverage
Virtual World Colliding with Practical Set
Vertical vs. Horizontal Cam Movement on Jib

LED operations flowchart provided by Lux Machina.

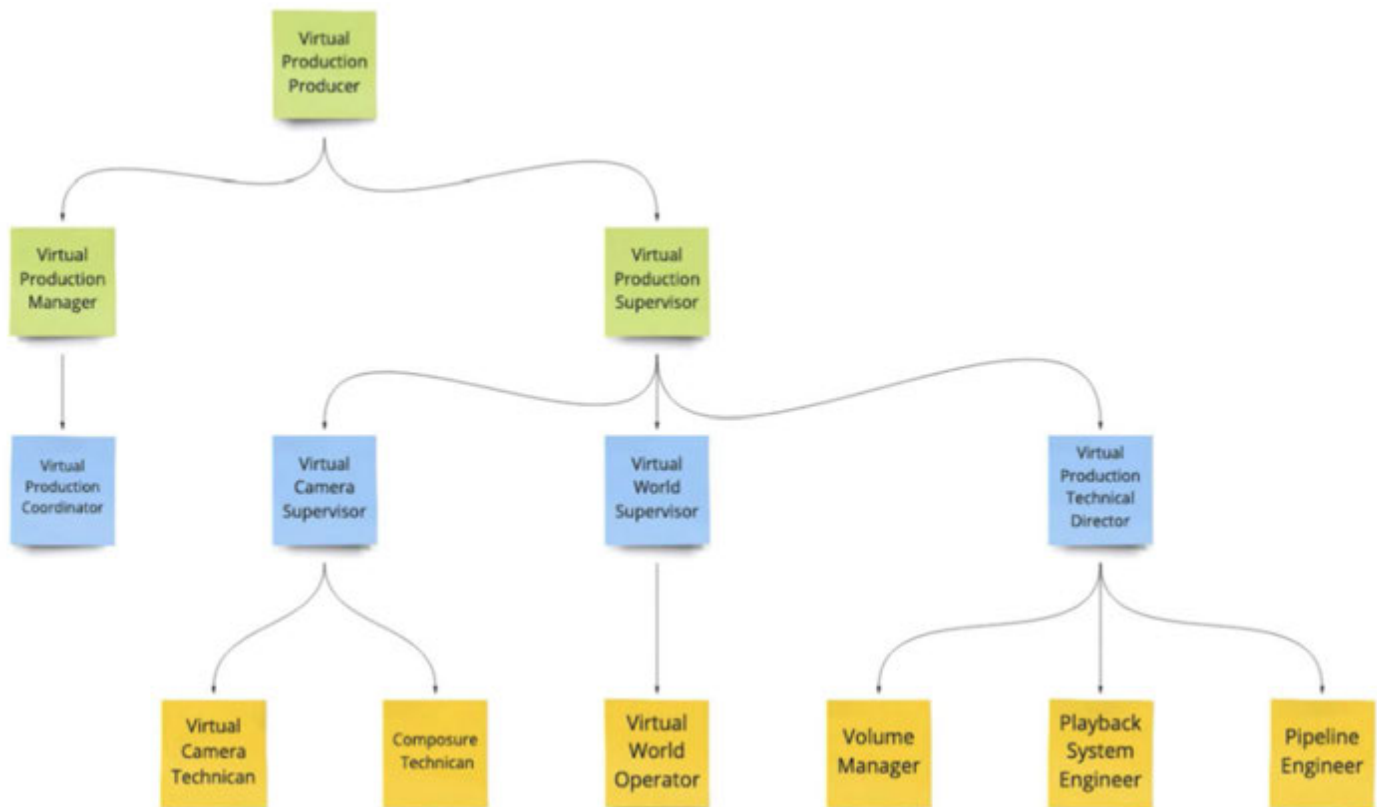

At Global Trend Pro's XR Stage, we worked with multiple vendors to operate our stage and manage camera tracking, Stargate Studios and ICVR. GTP's building manager would power on the stage and make sure the computers running and the walls were operational. They worked with Stargate Studios to properly configure nDisplay and their Unreal Engine set up with LED walls. Stargate brought in a multi GPU set-up that allowed them to synchronize the screens from our stage floor as well as set up a camera tracking system. ICVR provided their own hardware to control on-set VAD and content playback. ICVR and Stargate developed a UE multi-user workflow for collaboration on stage.

Coordinating efforts between three vendors to manage stage operation, camera tracking, and playback was a demanding process during our pre-production phase. We had to make sure that each vendor knew the role they were taking on in preparation and execution of our shoot. It was just as important to prepare creative packages for these vendors as the VAD team or VFX team. The creative drives the plan and stage operations need to know what tools they need to engineer in advance of the shoot to anticipate problems that will need solving on set.

With our compressed schedule, Stargate and ICVR had very little time to build tools that would streamline our process. Our focus as a team was to discover our on-set workflow as a team, isolate errors, and use simple tools such as a horizon line checker or stage alignment tool for our VP supervisor's needs on set. With more time at the beginning of the project, we could have worked together to build a broader toolset and a more streamlined workflow.

On Lux Machina's stage, our process was highly streamlined. Lux Machina's team works with their stage on a daily basis. They understood its strengths/limitations and provided consulting and coordinated teamwork on set. Halon Entertainment and Lux Machina have an established relationship as well, which helped significantly with their hand off of VAD content during our test days. Halon had the ability to save camera metadata from our previs/techvis sessions and organized their project file so that exact shot framing, virtual rotations of the world, and lens metadata could be accessed on the fly. As the Battlefield was the most complex environment to shoot, these streamlined procedures allowed us to spend more time on set composing the shots instead of trying to get oriented in the virtual world. If we did not have access to these tools, we would not have made our shoot day.

- What are best practices for LED volume operations vendors?
 - Provide a Complete Team - physical stage engineering/stage build, stage operators, content playback, camera tracking/camera department specialist, VAD/VFX specialist.
 - Should be able to establish and provide documented specs for delivery/receiving pipeline with VAD and VFX vendors.
 - If they own the facility, have specialists dedicated to power supply and networking solutions.
 - Provide consulting for achieving best results on their dedicated hardware.
 - Air conditioning is required.
 - Consider sound in the design of an LED volume.

- How should they work with VAD?
 - Provide consulting for VAD Lead regarding volume dimensions, specs, and strengths/limitations of technology. The Visualization/VAD team may be the first point of contact for creatives where expectations need to be set. The more informed the VAD/Visualization Lead is regarding stage specs, the more accurate their techvis will be prior to arriving on set.
 - Establish and provide documented specs for delivery/receiving pipeline between VAD and stage operator.
 - Establish testing schedule for content optimization and troubleshooting. This should be determined by production, but test frequency should be determined by all parties involved

based on the content created.

- Space should be allocated on set for VAD representatives to assist and/or manage content playback.
- Make sure VAD Team and Stage Operations are working in the same version of UE. If they are working in different versions, it will take additional time to make sure the content is set up properly.
- If working remotely, VAD should be able to remotely view the stage operator's UE content playback monitor, a low latency live feed view from the camera, a wide witness cam view of the crew (for context), a video call with hardline connection to network on large monitor positioned near/next to stage operator, desktop speakers so that crew can hear VAD team.
 - Production should provide the VAD team with a schedule that outlines what the crew plans to accomplish with time of day references so they can follow along.
 - Production should communicate with remote VAD regularly to make sure they are aware of what is happening on set and know where crew is in their day.
- What are baseline delivery standards for VAD delivery to LED Volume Operators?
 - This will be dependent on each vendor's pipeline.
 - UE files should be delivered in the same version as the stage operator is using. (Production should be responsible for coordinating this between vendors, however, it is impactful if VAD and stage operators can share this info freely with each other.)
 - VAD should double check that textures, models, and scene set-ups have been optimized according to stage operations guidelines - further testing can inform this as well. Although stage operators can help on the day of the shoot, this needs to be sorted in advance.
- What info does Led wall operation team need from physical/virtual production at the beginning of the project? What does production need to share before testing and shoot days?
 - Creative Package clearly defining the plan and scope of work on stage.
 - Introduction to VAD team and any other relevant vendors to the process.
 - Production Schedule
 - Regular creative updates leading up to testing and the shoot.
 - Project Specs & Camera Department Gear list (frame rate, camera, lens packages, aspect ratio, etc).
 - Whether production plans to scan the volume for visualization team.

VISIBILITY & OBSERVATION

Live View was implemented on both xR and Lux Machina Stages. TTL (through the lens) Alexa LF and Crew Cam (BMD 4K Pocket Cinema Cam). Solutions included Teradek Bolt bonded cell and hardlined streaming devices and Teradek Core view for low-latency viewing for Director's remote work and restreamed via 5th Kind Core for general viewing. Note: This can also be resolved with QTAKE, but that requires onset playback headcount. Once we lost some of the original camera crew that person left. Plus we wanted to keep the headcount down.

The live cam/witness cam feeds implemented on *Ripple Effect* were critical for our directors, stakeholders, and remote crew. With our directors and crew in mind, we were able to provide a safe remote (optional) working environment during all phases of production. Our stakeholders were able to observe our entire process, from casual conversation via Slack all the way through viewing crew working patterns and live

camera feed on set. With a direct connection to our team at all times, their questions and observations could be implemented into our process in real-time. While on set, our Virtual Production team received immediate feedback from key contributors who had questions, comments, and concerns as they watched the camera live feed, elevating the quality of our final shots in camera.

PRODUCTION INSIGHTS BY DEPARTMENT

Virtual Production Director/Producer
Virtual Production Supervisor
Director of Photography

What needs to be understood more than anything else is the workflow required to successfully film dramatic scenes on a volumetric capture stage. As a director of photography we expect the normal set rhythm of block, light, shoot. The volume requires that one evaluates the virtual scene on several fronts first. Is the color correct? Is the lighting believable? Is the horizon correct? If there is motion, is it smooth? Will the screen read believably or do we need to double de-focus, i.e. short depth of field in camera augmented by a defocused virtual environment. How will the virtual environment actually light the set and where do we need to “turn it off” in order to create a believable look?

After that, we block. We light. We evaluate the virtual environment and its relationship to that which is real on the set, make adjustments, potentially adjust lights and then maybe shoot.

Not only must the camera department and directorial team be satisfied, but virtual production must be as well. This triad of leadership must be completely prepared with a plan for implementation in order to be successful both artistically and interpersonally.

The DP’s substantial experience with broadcast television was helpful in that we could see what we were shooting on Colorfast monitors and scopes. The DP is a waveform guy and being able to see exactly what was in legal color space spared the project a lot of headaches.

Our camera was set at 24P, with a shutter angle of 144 and a base ISO of 400, 800 or 1250. The Directors wanted some slow motion shots at the highest frame rate possible. With an ARRI LF shooting Open Gate this is technically 90fps. We were able to capture 48fps at a shutter angle of 288. But on any faster setting we’d see flickering.

The DP learned that the top and side screens can be used effectively as positive and negative fill. The fill can also be any color of the spectrum. This is accomplished by adding or decreasing luminance and/or chroma values to the virtual environment on those screens or by blocking them altogether using 2D screen “blocks” that can be sized to cover a portion of the screen or the entire screen with any level of luminosity, chroma or opacity allowing the virtual environment to show through or be blocked out.

Establishing a scene should not be so dependent on the typical wide shot. Wide shots are extremely difficult to make believable if the virtual environment is a non photoreal asset.

Game engine developers should create controls that are in the language of cinematographers. For example when the DP communicated with the environmental artist about depth of field, he learned that what the DP was seeing on the LED’s represented a setting of 1000. This meant the environment was

fully focused. The DP learned that if the setting was changed to 400, he'd get just enough defocus on the screens to get away with seeing large swaths while shooting a subject 6 feet off of a 35mm or 47mm lens at 2.8. If we went to 300, the defocus would increase substantially. At 100 there was no detail in the virtual environment. It seemed that he was getting what he was asking for, but because of some of the communication issues in these back and forths, it will be helpful to know if the game engine actually uses camera science language within its interface.

Evaluate if the screen you are using has a sweet spot. The DP found that keeping the lens perpendicular to the curved LED at the Lux Machina stage eliminated some moire issues we encountered. Lux Machina was our fourth and last setup. By then it had become apparent that the actors and setting must reset as if on a turntable, not the camera. This allowed him to keep the camera as close to a perpendicular orientation as possible.

Foreground elements are the cinematographer's best friend. Foreground that the lens can cross but also foreground elements in the virtual environment that add to the parallax and believability.

If you can, test all forms of camera motion prior to the shoot day. Always have a plan B. In this case simpler moves would have been much preferred and even handheld to accomplish what the directors wanted. We experienced banding and morie at times when the camera was required to move with the virtual environment fully exposed.

His wish list is an active virtual environment that can do that math that allows it to represent the actual depth of field that the lens "sees." Not just focused or de-focused, but mathematically applying the lens science to the pixels in such a way that what we see at a virtual 30 feet from the lens is what we'd see in a real environment.

Production Designer
1st Assistant Director
Script Supervisor
Wardrobe / Costume
Hair and Make-Up
Sound
Directors

Watching a lot of the promo material and behind the scenes videos of projects shot in front of an LED screen made you think it was a magic tool that could let you create any world and use it no different than a physical location. It was a little more complicated than that. Although, still pretty awesome. It was realized that there are a lot of ways that our eyes tell us that something isn't real that I had taken for granted. Does the lighting match? Does it reflect correctly? Is the perspective correct? How fast or often does something move if there is wind? Recreating a believable reality takes work.

[KEY STAKEHOLDER QUESTION]

- Are the directors happy with locked LED content wall over greenscreen where they can make decisions in post?

VIDEO/DATA PIPELINE, TECHNOLOGY INTEGRATION

Greg Ciaccio, Executive Producer & Head of Post and Production Technologies for *Ripple Effect*, was responsible for the technology and services used, from pre-production, all the way through production and post-production, including all the tools facilitating the remote workflows employed.

Previs and Infrastructure Planning

We used a Miro board to develop and document the production technology and data pipeline throughout the project. It allowed the technical teams to collaborate remotely on the set-up and configuration requirements.

In that same vein, Bluescape was used to provide a place for creative storyboarding and look discussions in previs and design. Concept artwork was kept on the board and facilitated conversations related to script breakdown, shot and asset planning, and production design.

It seems like a simple thing, and it's easy to overlook. However, as more and more work gets done remotely, visualization tools supporting real-time, iterative collaboration are critical to keeping everyone on the same page.

In addition to developing the technical requirements and workflow design, it became clear that crew positions related to COVID could be designed around available remote technologies.

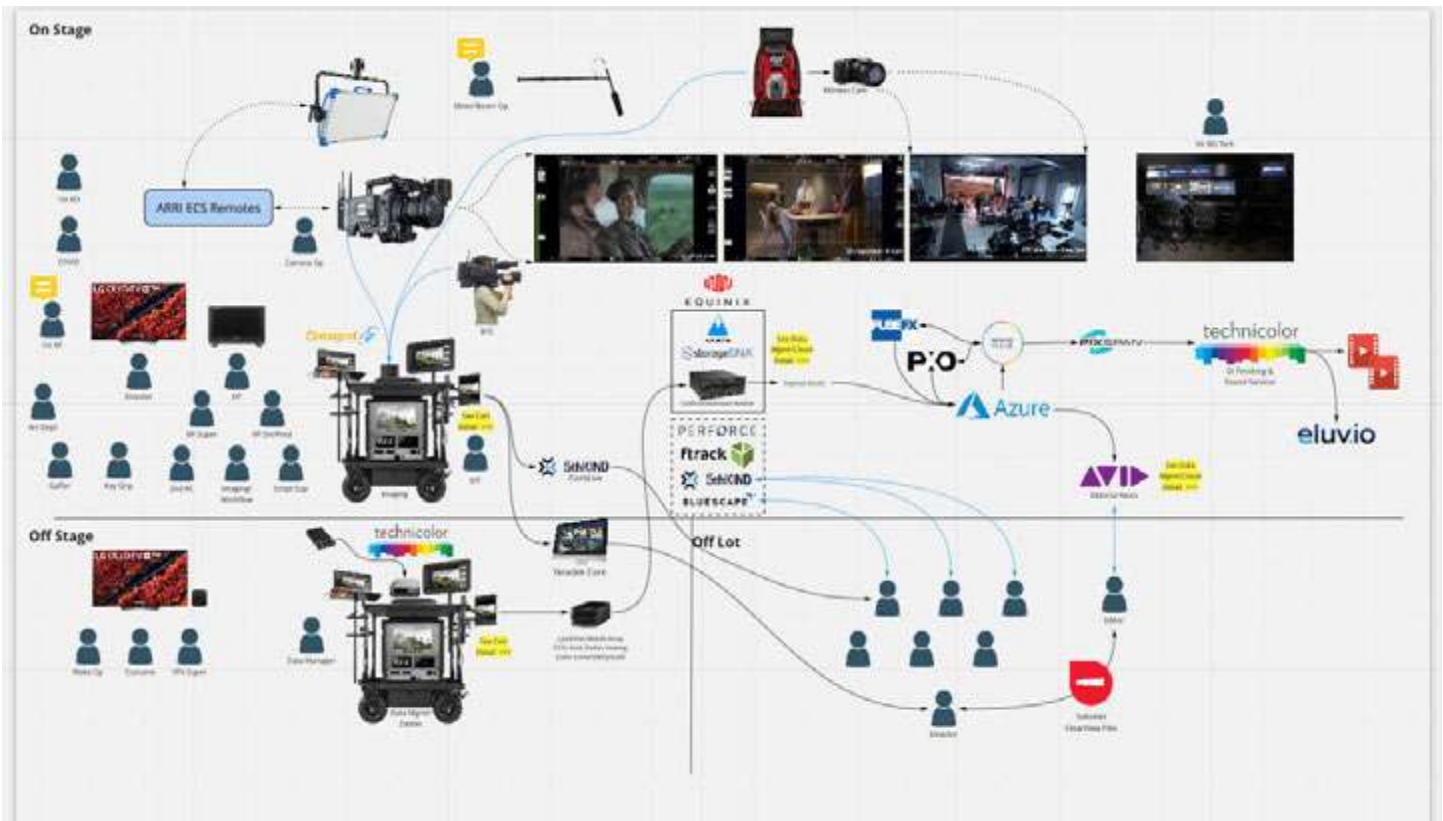

Miro board shows crew positions assigned per available remote tools allowed

Production Workflow:

The main camera was an ARRI Alexa LF, shooting open gate 4.5K ARRIRAW with a creative aspect ratio of 1:1.85. We chose a Blackmagic Design Pocket Cinema 4K camera as our ‘Witness Cam’ and employed several BTS Cameras that were recording throughout the project. And all production material was being shot to deliver in 4K/UHD HDR.

We used Teradek wireless video transmitters to deliver the camera feeds for monitoring. They gave the operators great flexibility, freeing up their movement, and eliminating the need to touch and wrangle cables.

The main camera used a Teradek Bolt 4K, which provided uncompressed 4K (10-bit 4:2:2 HDR) to the video village with imperceptible loss/latency. The ARRIRAW footage was captured to Codex SXR media.

The Blackmagic Design Pocket Cinema 4K witness camera was fed to a Teradek Bond Backpack. We used the backpack to house the Cube Wireless Video Transmitter feeding the DIT cart and video village for our purposes. The bag, as its name would imply, houses a modem that bonds together up to 10 devices, including a combination of Gigabit Ethernet, Wi-Fi, and multi-cellular connectivity, and is capable of transmitting across all of them to aggregate the bandwidth for up to six hours using the large battery onboard.

The BTS camera recorded to internal storage cards. The DIT cart was provided by Dane Brehm’s Cintegral Technologies; all of the feeds landed here and were then pushed to both Teradek Core, and 5th Kind CORE Live, for remote live and “live-enough” monitoring purposes.

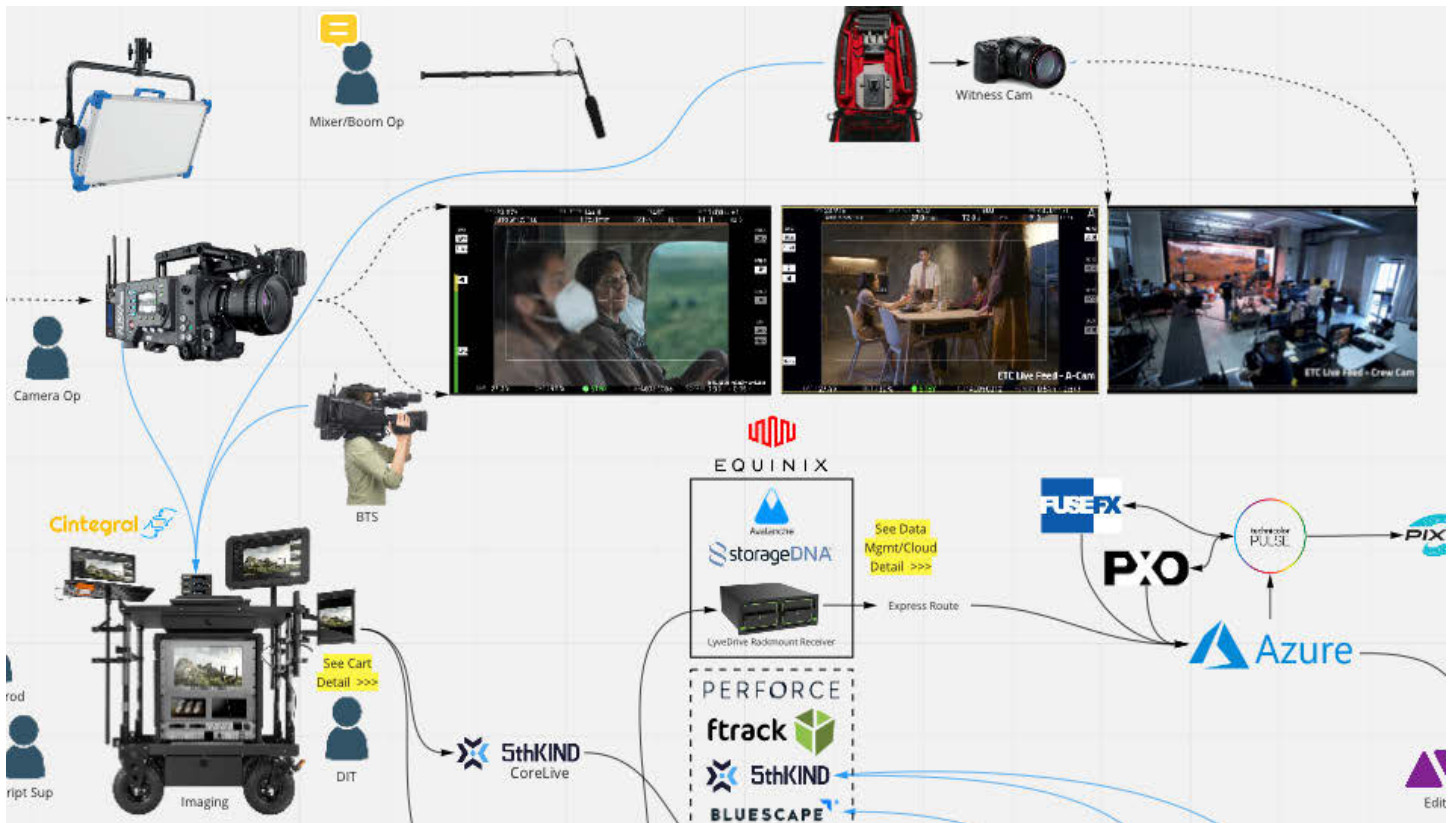

We used the ACES 1.2 workflow and output UHD (3840x2160) (Dolby Vision & HDR10) for TV and (future) 4096x2160 for the theatrical in P3 EDR/HDR, using the SMPTE ST-2084 EOTF. The creative aspect ratio is 1.85.

The DIT cart had a Sony X300 reference monitor used by DIT, Head of Production Technology, DP, VP Director/Producer, VP Supervisor, and Script Supervisor. There was also a 65" LG C9 television calibrated to match the X300, and another off-set that provided a large enough image for the crew to watch.

A Data Manager would offload their CODEX capture drives and memory cards at a small data management cart. And near the end of the shooting day, we would reach out to Chris Armstrong at Technicolor, and he would remotely process the dailies and send out a dailies completion email.

The Editorial workflow was designed for the DNxHR media to be moved directly from set to Equinix, loaded to a Pixit mover and storage system and then to the Avid NEXIS virtual workstation in Microsoft Azure through StorageDNA. This flexible workflow would allow for a private cloud to host our Editor should it be desired to limit public cloud use for financial considerations. However, in practice, given the project's condensed schedule, it was not

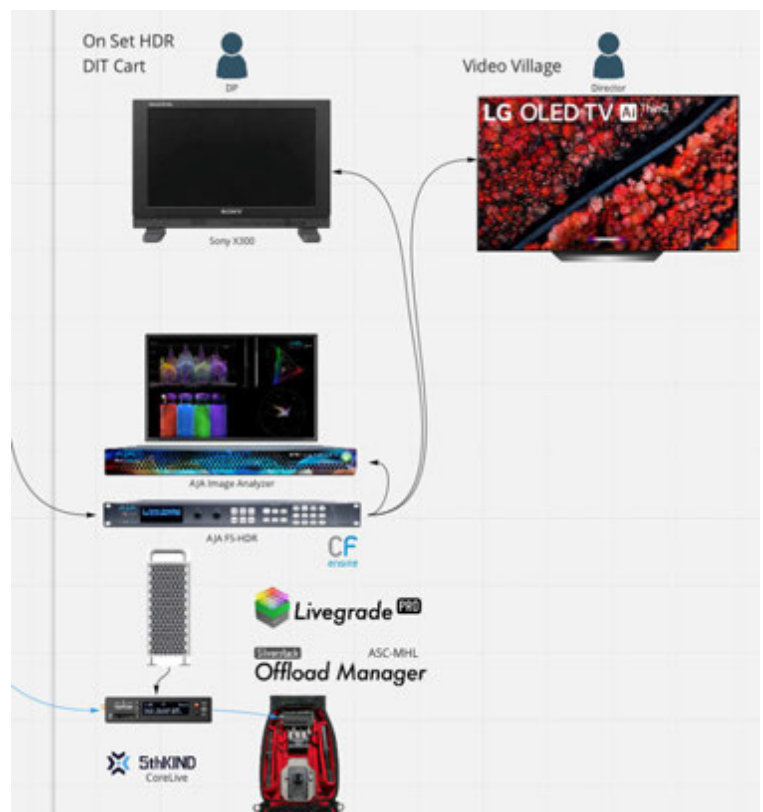

possible to get this configured early on. And it served as a reminder that getting integrations to happen across vendor solutions can require considerable lead times. We were, however, able to complete the workflow and our Editor was able to work with the Avid Cloud later in the project. The Avid Cloud was highly performant and allowed our Editor to work at home and at his work location when desired.

In addition to the X300, Codex Dock, and Teradek Receivers, the cart was configured with a Colorfront/AJA FS-HDR converter and an Colorfront/AJA Image Analyzer, which gave us the ability to monitor and measure both HDR and SDR on set. The FS-HDR, Color Analyzer and LG C9 display were provided by Colorfront, supported by Brandon Heaslip. (See *previous images*)

Remote Monitoring and Collaboration

To limit the number of people on set overall, the team set up remote monitoring and collaboration infrastructure.

We used 5th Kind CORE Live for all of the observational and review participants. This was extremely easy to set up and manage. As many studios and production companies have already vetted the platform, most everyone that needed accounts already had them. And configuring access for new users was straightforward.

Teradek Core was used for the Director, providing a very high-quality feed from the main and witness cameras to the Director off site on the east coast, with less than 2.5 seconds of latency. (Since this project, Teradek Core latency is now approx 4 frames.)

Sohonet provided two ClearView Flex boxes – one was used on a box on set to allow the Lux Machina team to collaborate with Halon Entertainment, who, for safety reasons, was only providing remote support at the time of the production. This worked as expected, delivering the Halon team a clear view of the stage, project and our team with only a few frames of latency.

The second Clearview Flex box went to our editor's home, where we ran into a use case that was functional but less than ideal from a technical perspective. Because the editor was working from home using Avid in the Cloud via Teradici PCoIP, we were doing a double compression operation on the material when running the Sohonet ClearView Flex sessions when the editor invited collaborators to see his screen. What is needed is true multi-viewer support directly from Cloud, bypassing the Editor's last mile. Zoom was used to augment CVF for communication.

[PER HALON ENTERTAINMENT]

- **Describe the remote collaboration process with filmmakers during the previs process.**
 - **What was the set-up?**
 - Previs Supervisor running Unreal on their machine.
 - Creative team logged into Zoom.
 - Supervisor shared their screen via Zoom.
 - **Were the remote sessions effective?**
 - Due to the time constraints of this project and limited review schedule, we were unable to evaluate the effectiveness of remote sessions beyond the reduced risk of COVID exposure.
 - **How is working remotely different from collaborating in person?**
 - Verbal communication via digital means (ie virtual meetings,, phone calls, etc.) effectively operates in half duplex rather than full duplex. As a result it's more difficult

to quickly respond to questions, points of interest, notes, tell when someone else has started talking when they are talking, etc.

- Remote work eliminates the possibility for vendors to do quick check-ins with the creative teams when they have a small break in their schedule.
- In-person collaboration allows for the development of professional relationships through non-task interactions (ex. small conversations while getting water). This can lead to more effective communication styles.
- Difficulties in delineating official vs. unofficial meetings.
- **What are the pros and cons of remote collaboration?**
 - **Pros**
 - Increased labor flexibility.
 - Decoupling of commute time and scope of work.
 - Reduced risk of COVID exposure.
 - **Cons**
 - Inconsistent color calibration across monitors.
 - Less fluid communication.
 - User's network connection is a potential point of failure.
 - Cannot set up a shared Derived Data Cache for Unreal between multiple locations.
 - Requires more robust network infrastructure for shooting locations.
 - Consistent on-set remote communication infrastructure.
 - **What were the tools and workflows used to facilitate remote collaboration in game engine for filmmakers?**
 - Internet allows everyone and their tools to connect to each other.
 - Zoom for screen sharing and audio communication.
 - Slack for written communication and sharing of reference images.
 - Email for further communication.
 - Perforce for sharing Unreal projects amongst multiple vendors.
 - Teradek for hosting remote video streams.
 - Sohonet ClearView for hosting remote video streams.
 - TeamViewer for sharing LED wall operator machine.
 - Text messaging for additional communication.
 - **Please identify any limitations and success to each workflow**
 - No singular official turnover location to ensure vendor/client deliveries.
 - Perforce Helix Core version control was used for sharing Unreal project and reusing assets amongst multiple vendors.
 - Perforce Streams - Success
 - Allowed for both a common depot and vendor-specific depot in the same project, creating a single source of truth. Team members visualize how changes would flow and reuse assets.
 - Zoom + TeamViewer - Success
 - Allowed closer collaboration between Previs team and LED wall operator that might not have existed had both teams been physically on set.
 - Zoom - Limitations
 - The Stage team would mute the laptop which was running Zoom. There was no way for the remote team to alert the stage team that they were trying to speak.
 - Teradek/Sohonet - Success
 - Allowed remote teams to view through the camera lens.

- Teradek/Sohonet - Limitations
 - Lag time between set and remote stream was 8 seconds.
 - Additional load on the Stage network.
- Slack - Limitations
 - No operational protocols in place for use of Slack channels.
 - Single Point of Communication - Limitation.
 - Having a single intermediary for communication inhibited quick turnaround between time of request and delivery of information.
- Internet - Limitation
 - Remote collaboration requires more network resources at the shooting location.
- **Are there other uses for previsualization other than filmmaking?**
 - Previsualisation is popular in many industries including, but not limited to: Automotive, Video Game, Architectural, Medical, Theme Park Rides, Educational, Military, Museums, and Photography.
- **How did techvis inform actor blocking?**
 - It allowed the creative team to know how much room they have to work with the talent for any given shot.
 - Shots were designed to allow for safe social distancing while achieving the appearance that actors were physically close to each other.

Data Management

As is often the case, bandwidth became a critical pain point along the way; the XR Stage, being a relatively new location, only had 35Mbps internet service and we could not secure high-bandwidth connectivity in time for the project.

To overcome potential bandwidth constraints, all content was copied to Seagate Lyve Mobile Arrays. The Lyve Mobile Array is a HW encrypted AES256, ruggedized, and portable high-capacity (up to 90TB of SSD or 96TB of HDD) RAID storage solution that enabled us to securely sneaker-net the content from the stage to the data center during the shoot at XR Stages, without the need for engineering/data management skills. It is available and can function as Thunderbolt 3 direct-attached storage, on its own, or can connect into a 4RU rackmount receiver in a DIT cart or in the data center. The user (in this case, the producer, Brendan Bennett) could take the drive to the data center, plug it in, and text someone, and they could take over.

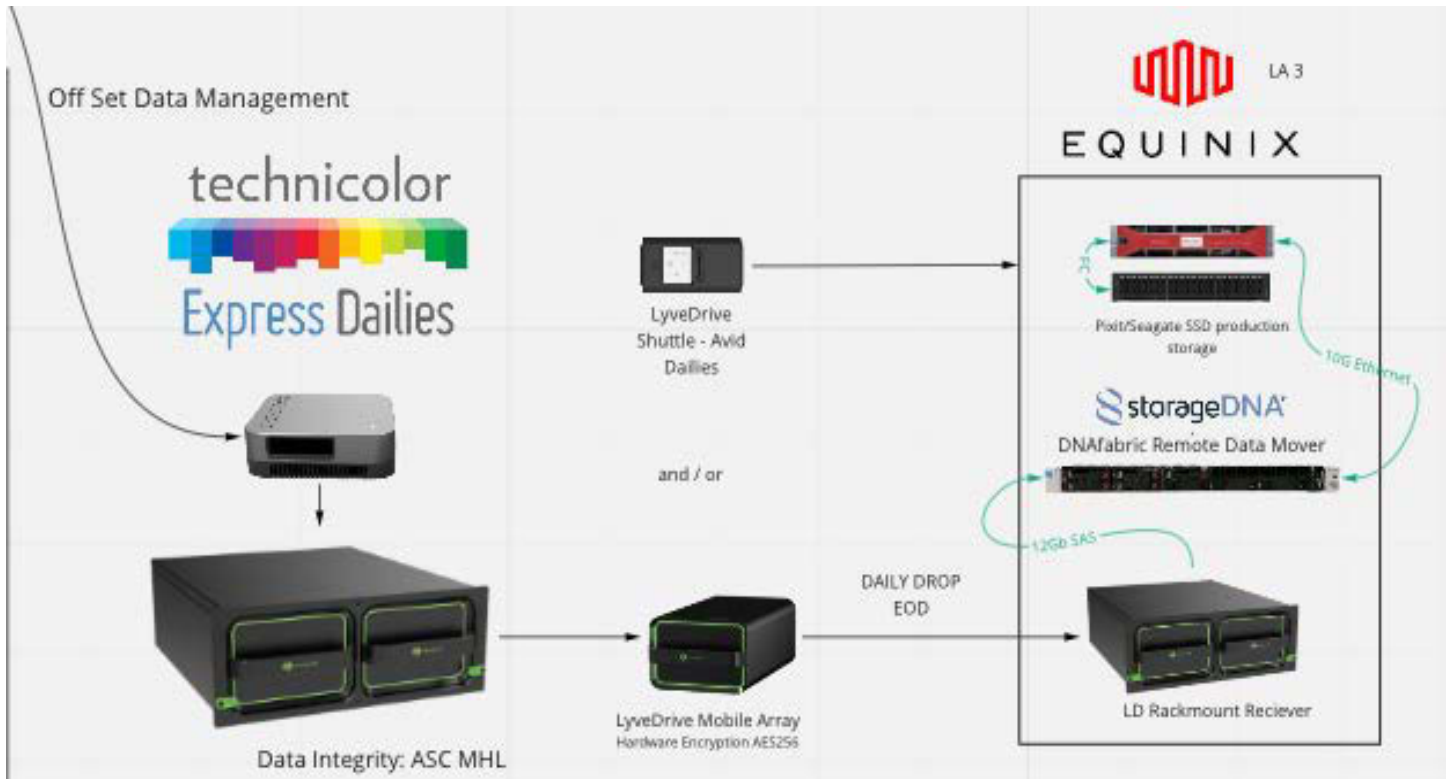

LyveDrive Mobile Array travels from set to Equinix Data Center

In order to place our infrastructure adjacent to our cloud service provider, the Seagate storage was hosted at Equinix Solution Validation Center in the LA3 area to enable direct, private and secure connectivity with cloud services providers, due to the Equinix Fabric.

Equinix Fabric allowed us to directly, securely, and dynamically connect to distributed infrastructure and digital ecosystems on platform Equinix using a single port.

Equinix Fabric can be used to connect to:

- Cloud Service Providers – Clouds, network, and other service providers
- Content Providers – Service Providers, Content Partners, CDNs
- Network Service Providers – NSPs, Last-mile, ISPs, IX and other peering platforms
- Enterprises – Other Equinix customers, vendors, and partners
- Yourself – Another instance deployed at Equinix

StorageDNA's DNAfabric served as the backbone for media movement and sharing. DNAfabric automatically transferred the data from Lyve Mobile Arrays to both our Pixit/Seagate SSD Production Storage. DNAfabric also synced data from the Pixit/Seagate SSD Production storage to an Azure Blob storage and from the Blob storage was synced to an Avid Nexis in Azure. The intermediate step of loading the media into Blob storage serves as a long term archive and also as a lower cost copy in the cloud for backup in case the Avid Nexis cloud storage suffered any form of data loss. Once the data was loaded on the Nexis, it was available for access by the editor.

DNAfabric further indexed and tracked every asset as it was offloaded and delivered. This information was augmented with cost metrics, storage metrics, geo-location tags, etc. This allowed us to track storage costs, storage utilization, data location, etc.

ETC PoC LA3 Physical Network Diagram

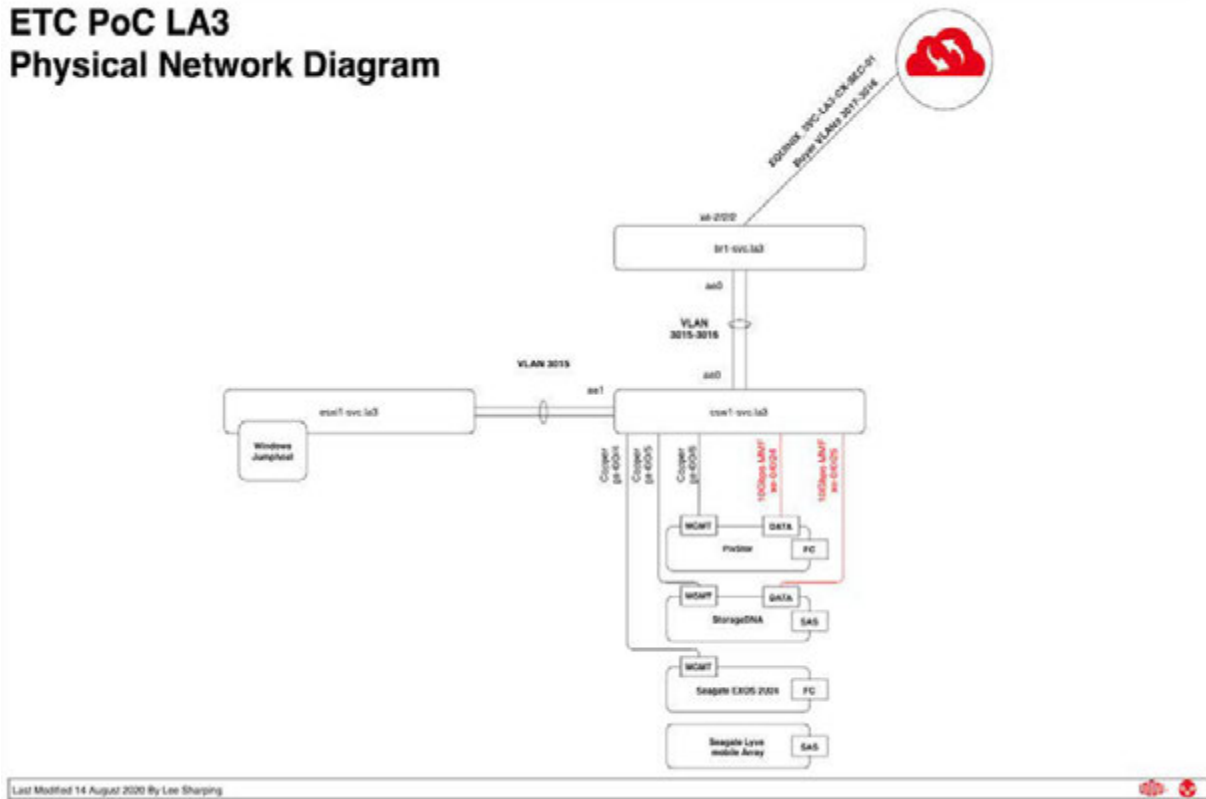

Equinix Network Diagram for “Ripple Effect”

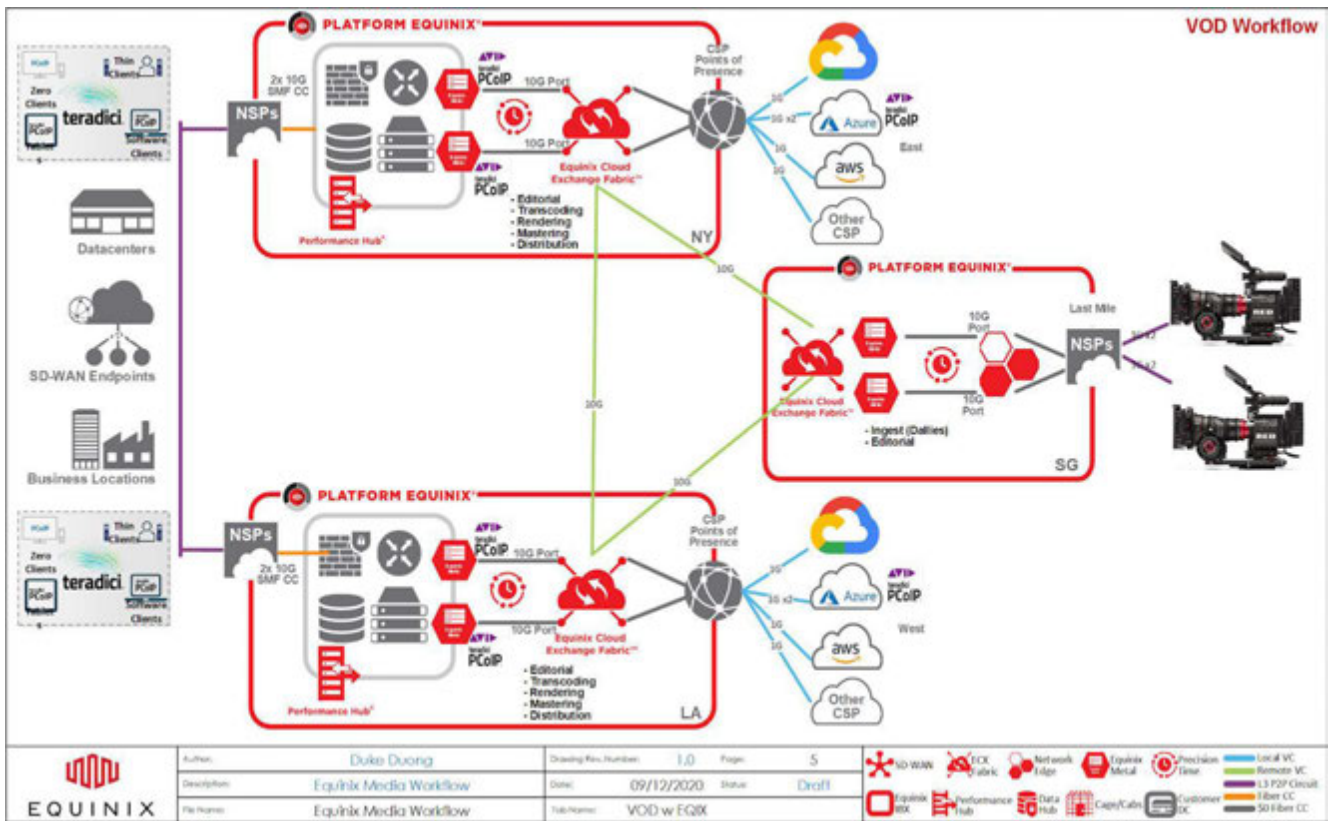

Equinix Workflow and Topology

POST PRODUCTION

Editorial

Though this was a single editor project, we emulated a workflow and infrastructure for a distributed collaborative editorial team to get a feel for the process and understand resource requirements.

Editorial used Avid Virtual Media Composer v 2020.6 using DNxHR LB to reduce bandwidth from the VM in Azure, with the ability to relink to SQ if needed to support previews.

The editor could get two screens (Avid Timeline & Source/Record, Bin, etc.) at home using Teradici PCoIP. This nominally requires ~30Mb/s down and 10Mb/s up at the editor's house. He would have preferred three screens, but was lacking the needed bandwidth at home.

Rommel Villa, our editor, was able to collaborate with our team using Sohonet's ClearView Flex platform with Zoom for communication as mentioned above under Remote Monitoring and Collaboration.

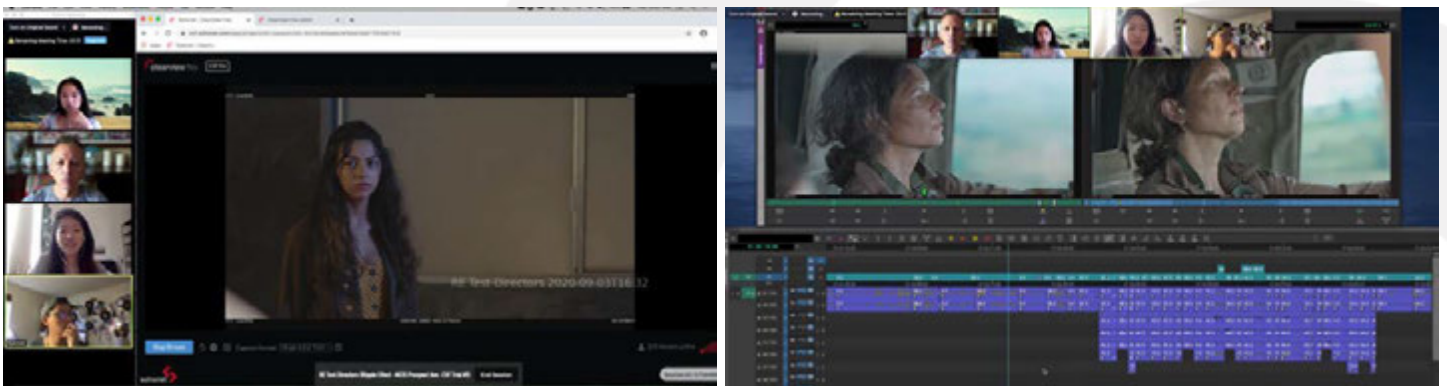

Editorial Review sessions using ClearView Flex and Zoom for communication.

Sound Editorial

Sound Supervisor/Editor, Cabba Cai, as well as our Composer, Jessica Weiss, communicated with our Directors and Post Team via Zoom. The bandwidth demands of audio are far less than of picture, so we could easily review high-quality sound over our Zoom calls. Versions would be distributed and could be reviewed in advance of our calls. An important note regarding shooting on virtual stages. Many are not sound stages, and background noise can be excessive. Cabba was able to filter out and attenuate fan and other ambient noise external to the stage using the iZotope plugin, which worked exceedingly well.

Post Finishing:

The DI

Jason Fabbro provided final color finishing at Technicolor. Color correction was supervised in-person at Technicolor by Directors Margo Sawaya and Hanna Bang as well as EP/Head of Post Greg Ciaccio. The current limitations of HDR color reviewing required that we reviewed in a calibrated environment with our colorist. Company policy limited room capacity to three, so we had two suites with matching calibrated Sony X300 displays. In addition, EPs Erik Weaver and Kathryn Brillhart reviewed color via Technicolor's TechStream, their streaming review and approval tool. Currently, the dynamic range of the stream was limited to SDR in Rec709.

Color Correction and Mix was supervised in-person at Technicolor by Directors Margo Sawaya and Hanna Bang as well as EP/Head of Post Greg Ciaccio.

Post Sound

The Dolby ATMOS mix was supervised in-person at Technicolor Sound at Paramount Studios by Directors Margo Sawaya and Hanna Bang as well as EP/Head of Post Greg Ciaccio and Sound Supervisor/Editor, Caba Cai. The mix was driven by Dialogue Mixer Joe Earle and FX Mixer Robin Warren. The Sci-Fi nature of the project made good use of Dolby ATMOS sound via subtle non-traditional background sounds placed in space to suggest an alien environment. It's noteworthy to mention that Cabba attended to assure that the Dolby ATMOS soundfield was mixed as intended. There are currently no approved methods of remote monitoring for Dolby ATMOS.



Dialog Mixer Joe Earle and FX Mixer Robin Warren mix "Ripple Effect"

Insights

The world of production evolves faster every day. Much of the work done is to address the “weak-link.” Like most productions, *Ripple Effect* was planned with multiple fallback options, knowing that there would need to be the need to evolve on the fly. An excellent example of this was the bandwidth limitations at the XR Stage. Without the sneaker-net option, leveraging the Seagate Lyve Drives, editorial and post-production may have been delayed by days. Similarly, during the company move from XR Stage to Lux Machina, we were informed that, due to the smaller space, we would need to limit our crew to around 10. Using remote systems, we were able to accomplish this. Additionally, the production start push of four days required a high-quality low-latency streaming solution to allow for our director to work from the east coast.

Meeting Cadence

As the world adapts to remote working, meeting cadence is something that should be considered with care. Daily meetings, while productive for some groups may not prove to be a good use of time for others. We found some feedback about this after the project wrapped. Rather than scheduling meetings for every discussion, productions should rely on tools such as 5th Kind and Slack for focused and organized collaboration centered around related media or subjects/concepts.

Post VFX

DESIGN FULL CG SHOT WITH HALON

How do you capture custom designed wide exterior shots if shooting on location is not available to you?

- Two main ways to capture wide exterior shots against LED walls (assuming the shots are framed wider than the LED wall itself):
 - Frame talent as needed, whether this framing goes beyond the edges of the set or not, and use camera tracking data to add set extensions in post VFX. (This can be done with or without greenscreen - either would require a unique workflow determined by creative).
 - Limit the frame to the dimensions of the size of the stage and the area that fits within creative frame lines. (This can be done with or without greenscreen - either would require a unique workflow determined by creative.)
- On *Ripple Effect*, our directors cut together reference footage from the film, *Mad Max: Fury Road* (2015), to show our Virtual Production team how they wanted to reveal the Truck and the Battlefield Environment. Unfortunately, this vision was presented to our VP team 4-5 weeks into the 8 week pre-production process.
 - Ideally, the director would be able to pitch their vision and execute it exactly as designed as early in the process as possible. This use case illustrates how schedule, budget and available technical resources can impact a director’s vision. The more a director understands the technical process for achieving their vision, the more proactive they can be in preserving the integrity of their ideas and continuing to centralize the team around their vision.
 - During the development/pre-production phase of our project we had the following limitations:
 - Directors new to visualization process and using tools that are key for communicating their vision (ie. storyboards, previs, techvis).
 - Delay in hiring Key Department heads.
 - VFX Vendors could not commit to open ended donation of time/materials, were only able to commit on a shot by shot basis.
 - Limited timeline for development & pre-production.

- Many decisions needed to be made early on that would impact the shoot - schedule felt compressed for directors who were learning the tech process at the same time.

It was important for our VP Team to manage expectations regarding Full CG shots (that would be requested of post VFX) and the directors were informed early in the development phase that wide reveals of the environment would be possible, however they would likely only be as wide as the LED wall configurations allowed. We suggested they plan in advance for this limitation as there were delays in bringing on a committed post VFX vendor. The longer it took to visualize their request, the less options they would have as we proceeded. A few limitations were:

- **Limited Post VFX Commitment** - Access to a committed VFX vendor at the beginning of the process would have given us more pathways to higher quality in-camera and post VFX.
 - For example, if we had a VFX team sharing and working on the same environment as the VAD team concurrently in pre-production, we would have been able to plan greenscreen frustum shots or plan for set extensions in general to achieve the director's original vision for this scene.
 - Smart stage LED walls are very useful tools for set extensions because the virtual camera data is being captured simultaneously with physical camera data. A live composited image can be captured at the same time as a shot with visible greenscreen frustum. The greenscreen frustum is shots are already tracked in that sense, once they are captured in camera. The tracking info can be applied to the shot in post and streamline the greenscreen replacement in post.
 - The editor of the project can immediately cut together the live composited shot as "postvis" until the background is replaced with final photoreal content from a post VFX vendor.
 - **Photoreal Quality will be Limited** - VAD Vendors had 4-6 weeks to build our environments. This time frame included previs and techvis, which meant the time VAD had to uprez and optimize assets was limited.
 - **Set Extensions Not Guaranteed** - Without clear visual representations of the shots required for this scene, we were not able to communicate what we needed to post VFX vendors and define a clear scope of work. The 4-5 week delay in receiving the edited clips eliminated this option for our team.
 - When shooting against LED walls in a studio, it is important never to focus the camera on the actual screen. The LED walls should always be slightly out of focus. LED walls are most effective tools when planned into shots as background elements, not as the focal point of a shot.
 - Set Extensions or Greenscreen Frustum would help a director work around this issue by giving more flexibility to improve photoreal quality of image in-camera or replace the background in post.
 - **Scope of Work** - With a limited schedule, we had to consider the following creative choices as they affected the amount of work we would need to request from vendors and evaluate what was possible to achieve on our time line.
 - Extremely wide aerial shots reveal more of the virtual world
 - The VAD or VFX team would need more time to build this out, uprez it, and optimize it.
 - Although *Mad Max* reference shows camera shot framing, it does not take into account that the directors were designing a lush world with grasses, mountains, and other vegetation - the wider the shot, the more assets need to be optimized to run in real time on the LED wall. This raised concerns early on.

- Seeing a wide exterior of the truck would require extensive practical set design. We did not have the budget to build out a practical set floor for the truck scenes. The request was made too late in our schedule to shift those resources.
 - Any exteriors or shots of the truck would need to hide the set floor to avoid set build.
 - This eliminated the (top left) reference image in the proposed sequence.
 - The environment was not a desert - it was a world with lush vegetation and this also caused concerns about continuity between LED stages.

CHALLENGE:

How do you capture custom designed wide exterior shots if shooting on location is not available to you?



Our Directors cut together reference footage from the film, *Mad Max: Fury Road* (2015), to show our Virtual Production team how they wanted to reveal the Truck and the Battlefield Environment.

Image shows the director's vision for shot structure at the end of the Battlefield scene.

Our VP Team worked with the directors and Halon to previs and techvis one full CG shot. This way, the directors would be able to have a guaranteed wide shot that went beyond the limitations of the LED walls and so that the VP Team could pull in a post VFX to help execute with a clear vision for what their scope of work would be as well. To reduce the scope of work for our post VFX vendor, the ETC VP Team, Halon, and the Directors decided to move forward with a wide aerial shot of the environment including a short distance camera pull back and the truck driving down the road.



SOLUTION:

To reduce the scope of work for our Post VFX vendor, the ETC VP Team, Halon, and the Directors decided to move forward with a wide aerial shot of the environment including a short distance camera pull back and the truck driving down the road.

Proposed Wide Shot



Actual Wide Shot



SAME SHOT: Horizon line can be much lower to half of screen so sky fills up half. Anything beyond the scope of the battlefield already built in the engine can be repetitive or shrouded with atmosphere to not have to build new assets

The directors were informed early in the development phase that wide reveals of the environment would qualify as full CG shots and would need to be planned with a post VFX vendor.

When shooting against LED walls in studio, it is important never to focus the camera on the actual screen. The LED walls should always be slightly out of focus. LED walls are most effective tools when planned into shots as a background element, not as the focal point of a shot

Image on left shows the original proposed wide shot. Image on right shows footage captured in camera at Lux Machina.



Design & execute full CG Shot(s) with FuseFX

FuseFX used Halon's project files to create the final full CG aerial wide shot for our directors. The image above shows a temporary still frame from the shot.

"FIX IT" shots - VP guidelines for Post VFX

The virtual production director created guidelines for post VFX "fix it" shots.

- Post VFX will not add reflections or integrate the entire length of the practical and virtual set. It is never okay to replace or manipulate the content captured on LED walls. It is okay to add or enhance

practical set seam if post lighting/asset tweaks needed - Add only. No asset removal.

- It is okay to ask Post VFX to remove visible screen seams, remove visible production gear, and to remove crew reflections.
- Post VFX can create full CG shots. (Exterior wide shots needed to tell a story.)
- It is okay to ask Post VFX for small creative enhancements such as: adding a patch to a character's uniform, correcting visible text if the editor chooses to flop a shot, etc.
- Goal to enhance the images captured in camera via Color and Editorial before requesting "fix it" help from post VFX.

VP Output Ties to Post Workflows / Vendors

There are several ways that VFX vendors and visualization companies can work together to create seamless, non-destructive workflows tailored to a Director's creative vision. How and when these companies work together is dependent on the creative challenges that need to be solved using virtual production techniques. And planning for virtual production output ties and workflows with VFX is a critical step that cannot be overlooked.

For example:

- If the goal is to capture final photoreal in-camera effects environments on LED walls, this would at minimum require:
 - A custom visualization to VFX workflow(s) to start as early as the pre-production phase.
 - Determining early in the process where the transition from previs quality assets to VFX quality assets would occur.
 - Determining whether the workflow will require a greenscreen Frustum during production and how this affects the transition from Previs quality assets to VFX quality assets.
 - Photoreal standards would need to be established at the beginning of the project as it will affect the transition from previs quality assets to VFX quality assets and Real-time rendering vs. traditional rendering.

Depending on the specific creative requirements for the project, there are several workflow variations for the output above. If the example goal were to change slightly, so would the minimum requirements.

It is possible to establish parallel workflows during pre-production and production and it is also possible to prepare for a transition from previs quality content to a higher VFX render quality content after immediately after the production phase or after postvis is delivered to editorial.

Open Standards such as USD can also help here. As with any sophisticated production workflows, proprietary formats, while often powerful, have the potential to create significant bottlenecks and resource constraints. And as is often the case may limit

GAME ENGINE COMPARISON

While this was something some of our stakeholders were interested in understanding, this is tricky as Unity simply cannot do what is needed for this production. Hence, setting up a completely new Unity pipeline would not work or deliver results. We primarily worked with Epic Games, Unreal Engine (Version 4.25) for

the Virtual Production workflows. Our safetyvis team, DigitalFilm Tree, worked in both Unreal and Unity to provide an interactive COVID safety product for Universal Studios. We can likely include these findings in our white paper via data from DigitalFilm Tree. We're anxiously awaiting NVIDIA's wholistic approach to VP, Omniverse, which takes advantage of USD (Universal Scene Description), an open standard.

CLOUD WORKFLOWS, MANIFEST AND ORGANIZATION ORCHESTRATION

Equinix Fabric in conjunction with Microsoft Azure ExpressRoute Direct interconnection improved the working of hybrid and multi-cloud performance in the following ways:

- Solved digital disruption with interconnection-first strategies.
- Provided a private network connection.
- Boosted cloud application performance, reduced latency, and improved scale, network control, and visibility to deliver a quality cloud experience to the end users.
- Delivered improved scalability that enables your enterprise to increase bandwidth, geographical accessibility, and easily grow the number of connected clouds within your network infrastructure.
- Controlled network connections at a granular level by enabling you to modify them through a portal or APIs.

Not relying on Equinix Fabric/direct connectivity, it would only be possible to connect via Public Internet where latency and bandwidth are not guaranteed plus can add threats to security requirements.

JUST IN TIME SCREENING ON THE ELUVIO CONTENT FABRIC

Introduction

The final stage in the *Ripple Effect* workflow was publishing the near-finished content to the Eluvio Content Fabric for just-in-time secure screening with individualized watermarking. The screening experience was made available in both 4K/HDR and HD options for browser, mobile and Apple TV. The Content Fabric is a decentralized global platform for just-in-time low latency, high-quality content distribution, monetization, and asset servicing. The platform is purpose-built to serve content at scale, eliminating the need for individual cloud transcoding services, aggregation, content management, and CDNs.

Video content is dynamically served directly from source objects as live and on-demand streaming, with dynamic sequences, and blockchain contract-based rights control secures the access and versioning of content. The Content Fabric software stack executes a decentralized data protocol on nodes implemented in a global network, and replaces and consolidates the conventional functions of live ingest, cloud origin, live transcoding, content management, encryption/DRM, program sequencing, rights and avails control, CDN streaming, and static content distribution. The nodes are peered directly with all of the major public clouds (AWS, Azure, GCP) allowing for local ingest from cloud storage buckets, and have high capacity (multi-terabit/second) IP transit capacity for direct ingest of live content and distribution of streaming and static content to audience.

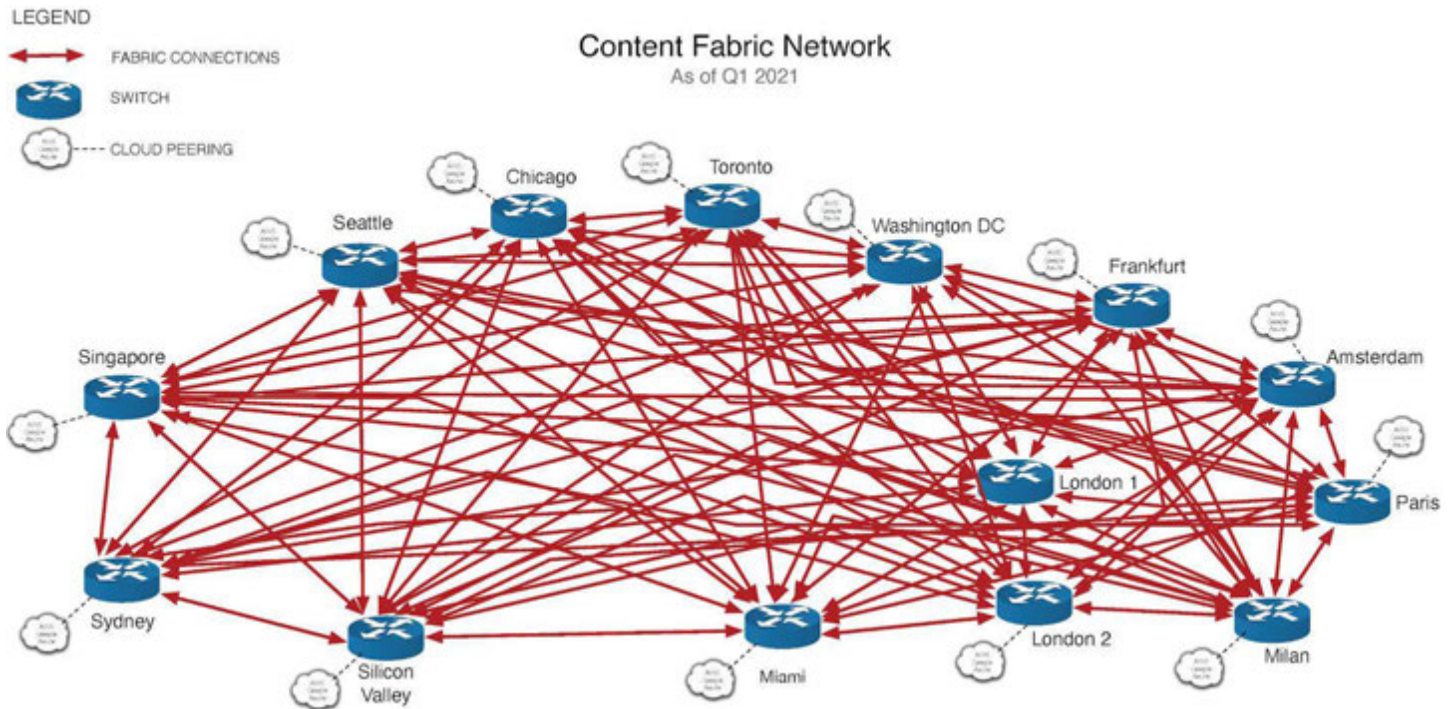

Figure - Content Fabric global network of nodes

Content Fabric Technology Background

The Content Fabric creates and serves output such as adaptive bit rate streaming manifests and segments, and static content through a just-in-time process that executes within the nodes in the network. This process relies on the Fabric’s decentralized data storage and distribution protocol and a componentized object representation of media essence, metadata and code called a “content object.” The content object is a data structure comprised of references to the cryptographic hash signatures of the binary “parts” that comprise the object. On ingest – master file media, assets, data, or streams – are decomposed by the Fabric software into such parts, distributed throughout the network, and an object is created. Any re-use of the parts within an object is by reference – rather than by copy – and common bytes are copied only on update. This is carried through rendering, such that all re-rendered output is built from parts, avoiding all file copy representations through the network and in storage for efficiency.

The Fabric’s fast part routing protocol allows for parts to be found in the network in real-time and supports just-in-time transcoding, packaging and extensible A/V processing within the Fabric’s main process. Finally, the life cycle and versioning of a content object is controlled by a decentralized publish and commit process, and all parts are encrypted under the control of a blockchain contract that is part of each object. The cryptographic hash of an object is a Merkle hash of the parts of the object, and is committed in a contract transaction whenever a version change occurs, ensuring that the “parts” that make up the object are verifiable throughout the network, and that any object updates or accesses are authorized via blockchain security. For details on the Content Fabric, please see one of these deep dive references online.

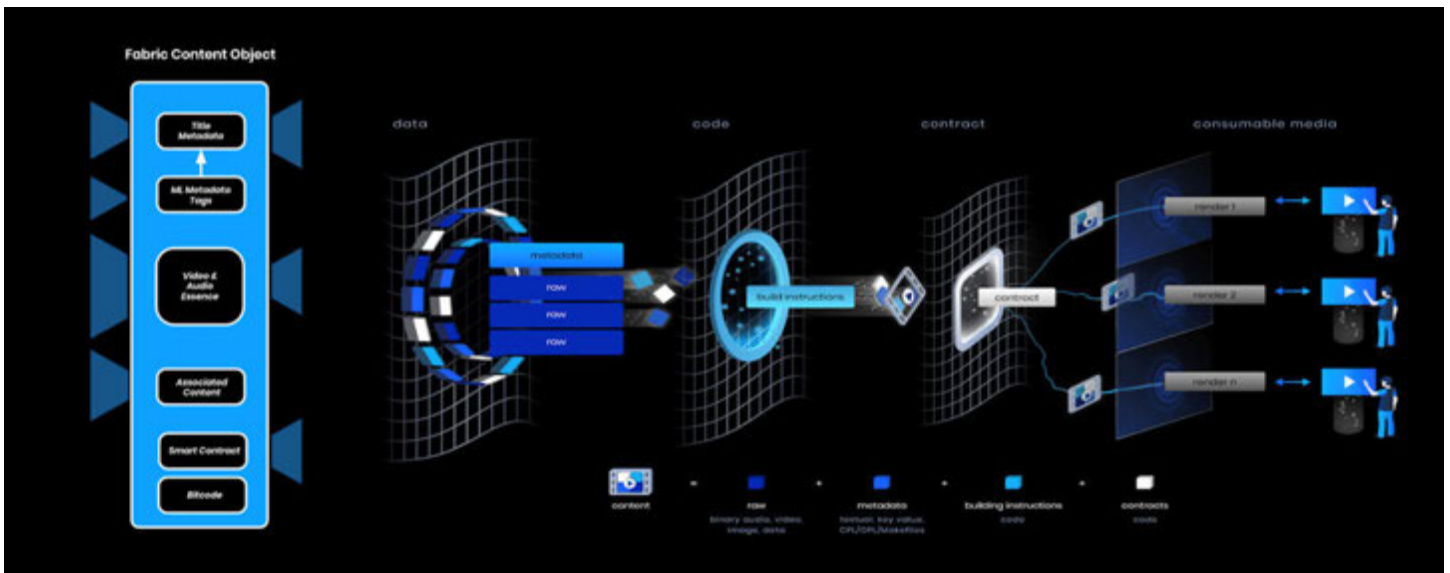

Figure - Content Fabric Componentized Content Object and Just-in-Time Output Composition

Ripple Effect Process

The *Ripple Effect* screening workflow used the Eluvio Content Fabric in a straightforward just-in-time fashion, including five steps:

- **Publishing the Master Source Content** to the Content Fabric by creating Production Master Content Objects and ABR Mezzanine Content Objects for HDR/H265 and H264 playout versions and configuring the default bit rate ladder and DRM options to be available to viewers.
- **Configuring a Site Content Object** for static “slug-based” linking to titles and associated static content and metadata in front end UIs and metadata, and configuring title metadata on the ABR Mezzanine Content Objects.
- **Configuring alternative offerings**, including personalized watermarking.
- **Configuring availability profiles** (“avails” policies) to enforce availability and digital ticket codes for access under the control of these profiles.
- **ML tagging the ingested content.**

These steps are shown with screenshots and additional details below with detailed references for further reading. (Note that while in this workflow the steps were carried out more or less in order, there is no technical requirement to do so. E.g. the source essence can be ingested after the content objects are created.)

Publishing the Master Source to the Content Fabric

The master files were supplied to Eluvio by Technicolor services by file transfer download. Two master source files were supplied:

1. A ProRes .mov file, 4K, 930 Mbps, with a frame rate of 24000/1001 (23.98 frames per second), with a total duration of 11 minutes and 26 seconds, the first 1 minute 30 seconds of which is leader content, and 8 mono audio streams, the last two of which were a stereo downmix pair.
2. An H.264 .mov file, 1920x1080, 24000/1001 frame rate (23.98 frames per second), with a total duration of 10 minutes and 10 seconds, the first 10 seconds of which is leader, and a single (2

channel) stereo stream.

Eluvio ingested the masters by reference from the downloaded file sources using the Content Fabric APIs to create a Production Master Content Object. This process interrogates the source file to create descriptive data structures and references to the source files to use in creating derivatives.

Figures Below: Production Master Content Object for the ProRes source, and Right: detailed metadata structures

The screenshot displays the Eluvio interface for a Production Master Content Object. The main panel shows the object details for 'ripple - Title Masters > Ripple Effect HDR RPL_ETC_P360_ProRes_4444_XQ_120420 MASTER'. Key information includes the Name, Description, Access charge, Library ID, Object ID, Type, Contract Address, Owner, Permissions (set to 'Editable'), and Versions (3). The Latest Version section shows the Hash, Type, Type Hash, Commit Info (Author, Commit Message, Committed At), and Metadata. The Metadata is displayed in a 'Formatted' view, showing fields like 'bundle_meta', 'commit', 'description', 'eluv.caps', 'eluv.created_at', 'files', and 'encryption'. The 'files' field lists the source file 'RPL_ETC_P360_ProRes_4444_XQ_120420.mov'. To the right, a detailed JSON metadata structure is shown, including production_master, sources, container_format, duration, filename, format_name, start_time, streams, and master.display parameters.

created describing the source

Eluvio then used the Fabric's APIs to create ABR (adaptive bit rate) Mezzanine content objects from the Production Masters. ABR Mezzanine objects are a content object comprised of a high bit rate (configurable without limit in top bit rate) transcoded version of the master stored as hashed 'parts' of 30 second duration from which all streaming output is created, and any metadata and associated file/static content, also stored as 'parts' in the object. The object metadata is configured to present various "representations" that are generated at the time of playout such as HTTP adaptive bit rate (ABR) streaming. The top bit rate (quality) is configured when the object is published. Derivable outputs can be configured via metadata at any time (added, removed, changed).

In this workflow the ABR Mezzanine object created from the H.264 Production Master generates H.264 encoded HTTP ABR streaming manifest and segments packaged with DASH, HLS and DRM, and configured with a resolution ladder of 1920x1080@9.5 Mbps, 1280x720@4.5 Mbps, 960x540@2.0 Mbps,

768x432@1.1 Mbps, 640x360@810 Kbps, 640x360@520 Kbps. The ABR Mezzanine object created from the ProRes Production Master generates H.265/HEVC encoded ABR with HDR with a single offering of 3840x2160@16.7Mbps. The Content Fabric uses fragmented MP4 encoding with 1 frame per fragment, and CMAF segments for DASH and HLS. For more information on the streaming mechanism, low latency throughput, and quality, please refer to this technical talk at DEMUXED 2020.

The screenshot shows the eluvio interface for a content object named "Ripple Effect HDR ME2". It includes fields for Name, Description, Access charge, Library ID, Object ID, Type (Ripple - Title), Contract Address, Owner, Permissions (Viewable), Versions (12), and Latest Version. The Latest Version section shows a Hash, Type (Ripple - Title), Type Hash, Commit Info (Author, Commit Message, Committed At), and Metadata (Formatted, Raw). The raw metadata shows a JSON object with fields like log, entry_point, and media_struct.

This screenshot displays the "representations" metadata field, which is a list of video configurations. Each configuration includes fields for video_id, bit_rate, crf, height, media_struct_stream_key, type, and width. The list includes configurations for various resolutions and bit rates, such as 1280x720, 1920x1080, 1080p, 840x360, 640x360, and 768x432.

Figures - Above Left: ABR Mezzanine Content Object for the H.264 source, and Right: Configured bit rate ladder in the object's metadata. Below Left: ABR Mezzanine Content Object for the ProRes source, and Right: Configured

The screenshot shows the eluvio interface for a content object named "Ripple Effect HDR RP_ETC_P360_ProRes_4444_XQ_120420 MASTER". It includes fields for Name, Description, Access charge, Library ID, Object ID, Type (Ripple - Title Master), Contract Address, Owner, Permissions (Editable), Versions (3), and Latest Version. The Latest Version section shows a Hash, Type (Ripple - Title Master), Type Hash, Commit Info (Author, Commit Message, Committed At), and Metadata (Formatted, Raw). The raw metadata shows a JSON object with fields like bundle_meta, commit, description, and encryption.

This screenshot displays the "representations" metadata field for the ProRes source. It shows a list of video configurations under the "representations" field, including fields for prod_master_hash, prod_master_var_key, ready, simple_watermark, store_clear, and public. The configurations are for 3840x2160@16700000.

single bit rate in the object's metadata

At this stage the Fabric was able to serve streamable, playable representations for both ABR Mezzanine objects (known as "Title" content objects) from any of its nodes. The screenshots below show the default streaming view within the Fabric Browser. An embedded hls.js/dash.js player and elv-client-js display application act as a standard streaming client, authenticating to the Fabric using the elv-client-js APIs, obtaining a playout URL and authorization token, including being directed to a local/available Fabric node, and requesting playout. The console display shows the arrival time (first bytes and full 2-second segment) to the player.

The screenshot shows the eluvio Fabric Browser interface. The top navigation bar includes 'Content', 'Access Groups', 'Content Types', 'Contracts', and 'Events'. The main content area displays a video player with a scene of a man and a woman at a table. Below the player is a 'Segment Metrics' table with columns for ID, Quality, Size, Download Rate, Throughput, and Timing (ms). The table contains 8 rows of data. To the right of the video player is a 'Buffer Level (seconds)' graph showing a fluctuating line between 0 and 40 seconds. Below the graph is a 'Playout URL' field and an 'Advanced Controls' section with dropdown menus for 'Offering', 'Playout Handler', and 'Playout Type'.

ID	Quality	Size	Download Rate	Throughput	Timing (ms)
166	3840x2160 (60/50 Kbps)	1.82 MB	327 MB/s	75.5 MB/s	126
165	3840x2160 (60/50 Kbps)	1.67 MB	230 MB/s	125 MB/s	117.81
164	3840x2160 (60/50 Kbps)	1.30 MB	161 MB/s	66 MB/s	101.99
163	3840x2160 (60/50 Kbps)	1.87 MB	54.7 MB/s	44 MB/s	111.228
162	3840x2160 (60/50 Kbps)	1.42 MB	138 MB/s	95.8 MB/s	111.91
161	3840x2160 (60/50 Kbps)	1.85 MB	334 MB/s	128 MB/s	114.2
160	3840x2160 (60/50 Kbps)	1.78 MB	282 MB/s	118 MB/s	114.2

The screenshot shows the eluvio Fabric Browser interface. The top navigation bar includes 'Back', 'Manage', 'Custom Contract', 'Upload Parts', 'Groups', 'Apps', and 'Delete'. The main content area displays a video player with a close-up of a woman's face. Below the player is a 'Segment Metrics' table with columns for ID, Quality, Size, Download Rate, Throughput, and Timing (ms). The table contains 8 rows of data. To the right of the video player is a 'Playout Options' section with tabs for 'Live' and 'HLS', a 'Buffer Level (seconds)' graph showing a rising line from 0 to 40 seconds, and a 'Playout URL' field. Below the graph is an 'Advanced Controls' section with dropdown menus for 'Offering', 'Playout Handler', 'Playout Type', 'Region', and 'Fabric Node'.

ID	Quality	Size	Download Rate	Throughput	Timing (ms)
26	1920x1080 (60/50 Kbps)	2.08 MB	103 MB/s	116 MB/s	117.126
27	1920x1080 (60/50 Kbps)	1.92 MB	104 MB/s	121 MB/s	117.116
26	1920x1080 (60/50 Kbps)	2.14 MB	103 MB/s	116 MB/s	117.116
25	1920x1080 (60/50 Kbps)	2.05 MB	112 MB/s	82.4 MB/s	117.117
24	1920x1080 (60/50 Kbps)	2.14 MB	103 MB/s	101 MB/s	117.116
23	1920x1080 (60/50 Kbps)	2.23 MB	114 MB/s	83.7 MB/s	117.116
22	1920x1080 (60/50 Kbps)	2.37 MB	84.8 MB/s	68.8 MB/s	117.117
21	1920x1080 (60/50 Kbps)	2.35 MB	55.4 MB/s	52.1 MB/s	117.116
20	1920x1080 (60/50 Kbps)	2.47 MB	39.4 MB/s	38 MB/s	117.116

Figures Streaming playlist from the two Title Mezzanine objects from within the Fabric Browser.: ABR Mezzanine Content Object for the H.264 source

Configuring a Site Content Object

The ABR Mezzanine Content Objects, now streamable, were then added to another content object structure for presentation consumption in front-end UIs. This object, referred to as a “Site Object,” is a content object that exploits the linking capabilities of the Content Fabric to allow for static “slug” referral to content objects in the front end, replacing the need for a Content Management Service. The Content Fabric includes the ability to create named links from one content object to another content object, or from a content object to a “part” within that object, much like symbolic links in a file system. These links can be resolved at request time, allowing for a requesting application/UI to refer to any content object element by name and receive back a dynamically resolved version hash. The resolution of a named link works much like “slug” resolution within URLs in that the slug is a static string name within a content object that can refer to any current or past version hash and is transparent to the requesting application.

Specifically, the Site object is itself a content object pointing to (linked to) other content object elements that are playable representations, images, metadata or collections of any static or dynamic content. In this workflow the Site Object was configured to point to the two ABR Mezzanine content objects as titles in a list of playable titles. The ABR Mezzanines themselves were configured to include links to images uploaded to their objects as poster slugs (using the Content Fabric’s “files” API). Through link resolution in the underlying Fabric functionality, the Site object provides a static naming structure for resolving the ‘pointed to’ elements at request time, including specific versions (hashes) of linked objects.

For example, the browser based Sample Site for screening loads the Site Object by its unique ID, which itself has a slug `public/asset_metadata_titles/ripple-effect-h264` that refers to the public metadata section of the H.264 ABR Mezzanine Content Object, with the latest version hash `hq__3MZqypubpf1u3 ...`

When the Site Sample application is loaded, this linked path is resolved by the Fabric to return the specific linked version of the title object, including resolving any dynamic representations such as `../rep/playout/options.json` which returns the various playable manifest URLs.

The same principle applies to serving the inline posters such `.../public/asset_metadata_titles/ripple-effect-h264/images/landscape/default`

and to serving title metadata from `.../public/asset_metdata_titles/ripple-effect-h264/info/...`

This is a powerful and convenient mechanism for content management inline within the Fabric, and provides for virtually unlimited dependency resolution without ever changing the frontend UI.

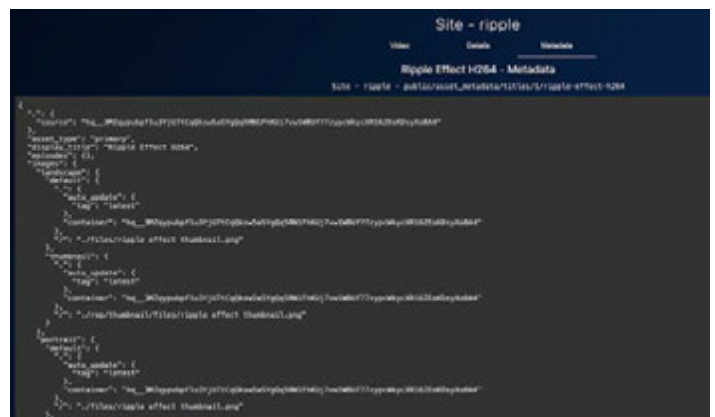
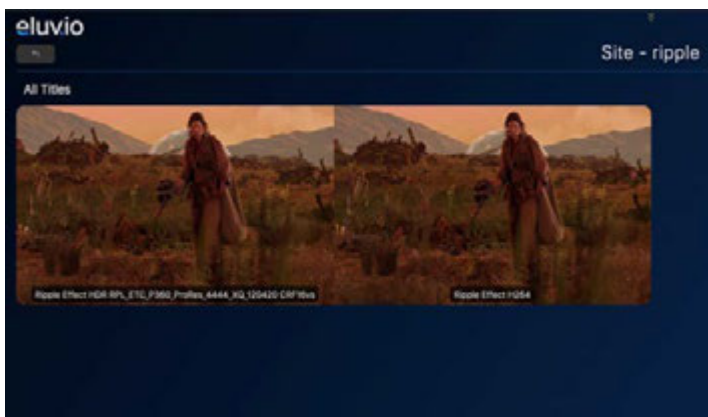

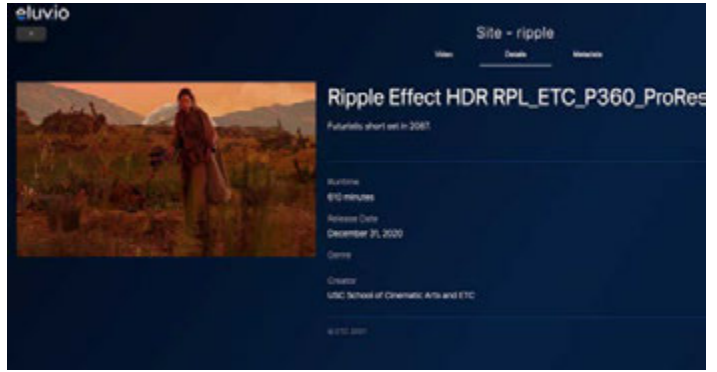
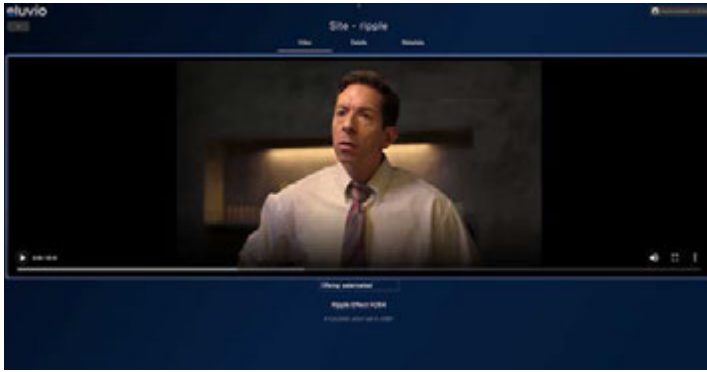

Figures Below - The browser-based screening sample site configured with the two playable titles. The application refers to the Site Object, and its “slugs” to resolve all playable content representations, images, and metadata on request.

Fabric Browser Applications for Content Management on the Site Object/Titles

The Content Fabric includes a mechanism whereby a content object (or a “type” of content object) can have one or more associated applications that operate on the object inline for display or management within the Fabric Browser management application. In this workflow, one such application, the Asset Manager application was used to configure the metadata on each title and to add the latest version hashes of each title to the Site Object. Note that both of these applications have an “Update Links” button, which when clicked activate the Fabric to update all of the links within the object to point to the latest versions of any parts that have changed within linked elements. For example, when title metadata was added to one of the ABR Mezzanine objects, a new version is committed. In order to reflect that new metadata on the Site Sample, all that was needed was to “Update Links” on the Site Object and reload the

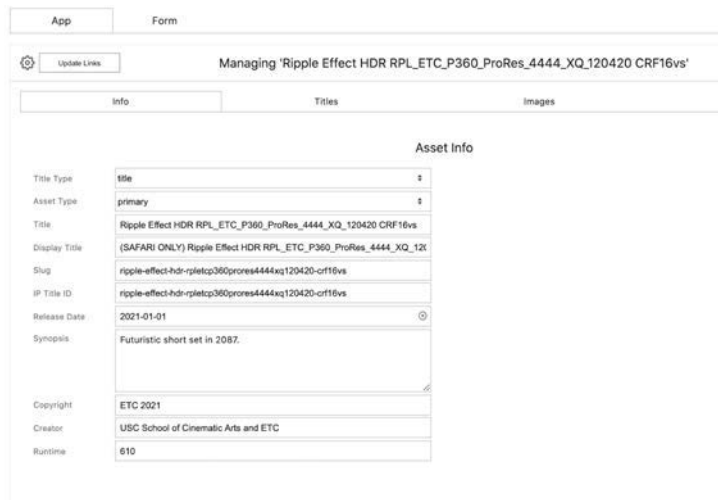
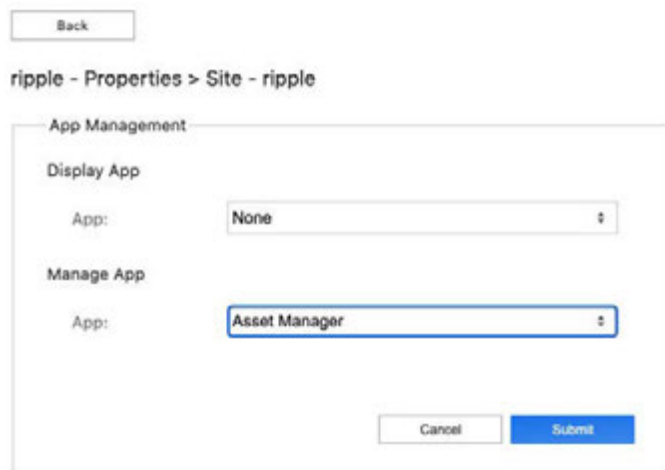
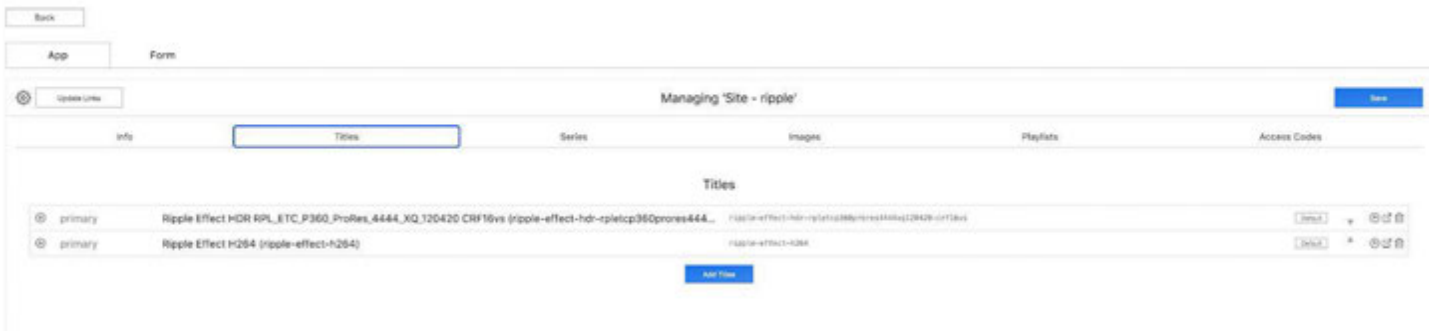

page.

Configuring Alternative Offerings

The third step in publishing the content offerings was to configure an “offering” on the Titles that the Fabric will generate to apply personalized watermarking just-in-time, via the Fabric metadata. This is a metadata driven profile that is read at the time of segment generation allowing the Fabric to apply custom transforms to the just-in-time transcoding on segment request, and can read in metadata from the session such as the user ID extracted from the authorization token. See for example the following metadata on a

```
    },
  },
  "prod_master_hash": "hq__J6dsatPaasnQM75UfxaCSwFsjaZ7eqbF8LQL1uv4PAyVHBLT489KtxSKLWKTvoVnmp3EkYWck",
  "prod_master_var_key": "default",
  "ready": true,
  "simple_watermark": {
    "font_color": "white@0.2",
    "font_relative_height": 0.015,
    "shadow": true,
    "shadow_color": "black@0.15",
    "template": "$USERNAME",
    "x": "(w-tw)/100*85",
    "y": "(h-th)/100*20"
  },
  "store_clear": false
}
```

mezzanine object:

Configuring Availability Profiles

Fourth, an Availability Profile was configured for both of the playable titles and associated with a unique digital “ticket.” This profile enforces authorization and access to playout for the title by policy associated with the profile including aspects such as date range, geographic restrictions on the client accessing, and the offering (watermarked or not, for example) that the ticket is authorized to. This mechanism is enforced through the blockchain contract interface on each object and the Fabric’s trustless re-encryption through a cryptographic mechanism whereby the ticket code presented by a front end on behalf of the user is validated by the blockchain contract for the ticket class, and against policy metadata in the contract of the object itself to return an authorization token allowing the playout or other access request to go through. An overview of this authorization architecture and the data flow for redemption of a ticket are shown below.

Figures (On the next page) Left - The authorization architecture in the Content Fabric, evaluating the authorization token against a policy bound to the content object’s blockchain contract. The authorization token can be obtained through a number of options including presenting a valid digital ticket evaluated against a ticketing service, or via other secure sign on mechanisms such as OAuth or native Fabric blockchain authentication. Right - The data flow for redeeming a ticket.

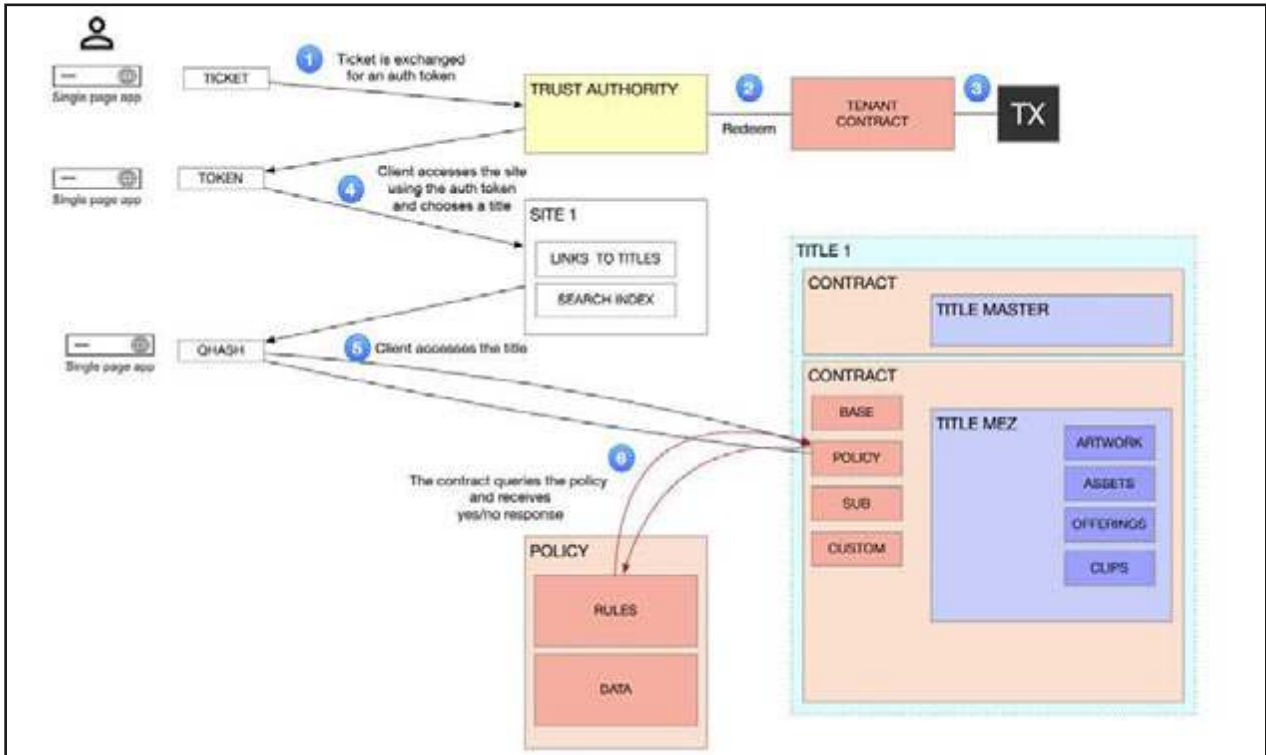
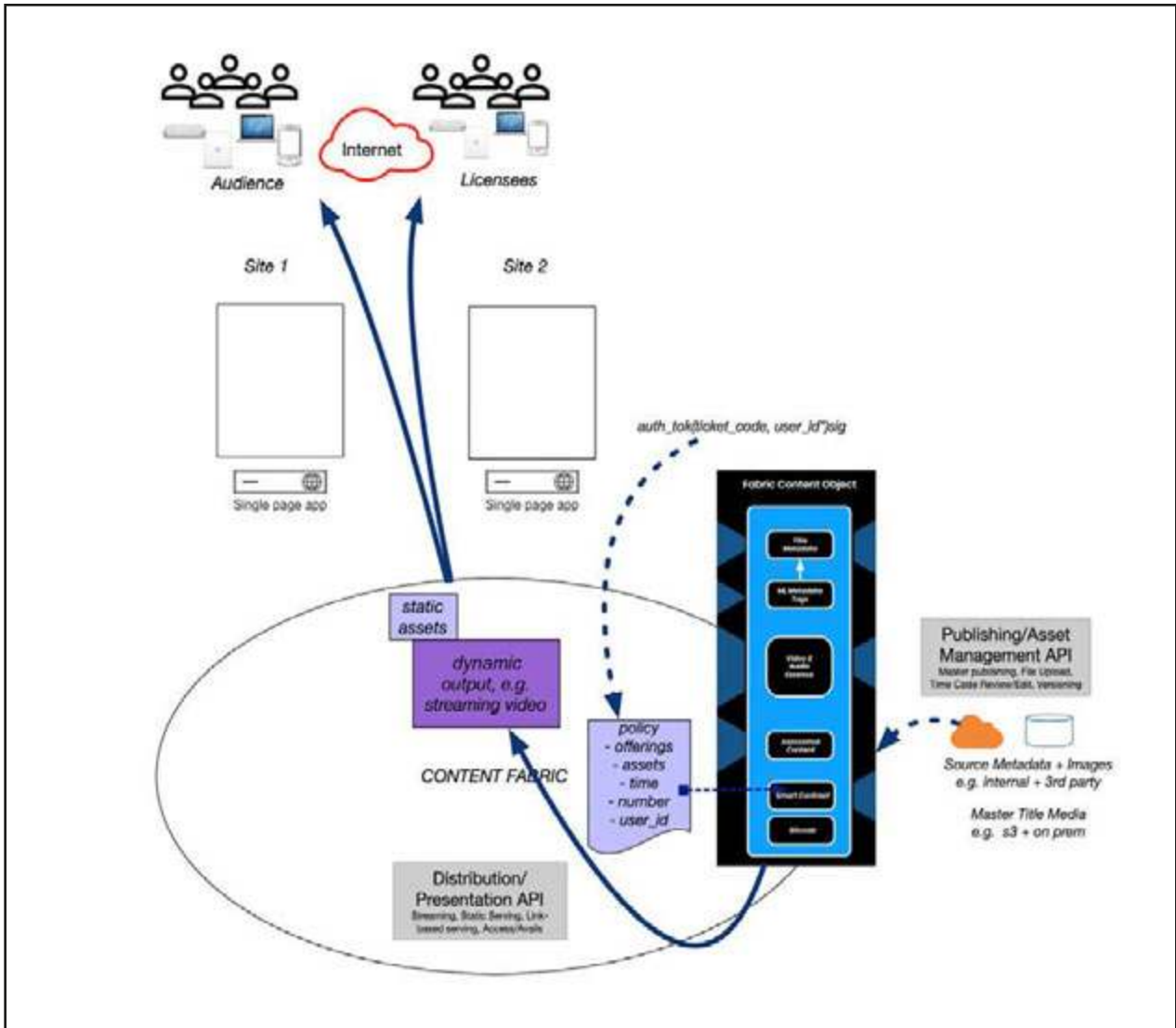

In the *Ripple Effect* workflow, availability profiles were configured for each of the Title objects with start and end dates, enforcing that the watermarked offering be the only authorized offering on one of the titles, for illustration. The Permissions manager application in the Fabric Browser was used; like the Asset Manager application it can be configured as the management application for a given content object or its type on demand in the Fabric Browser.

The screenshot shows the Eluvio interface with a sidebar on the left containing 'Content', 'Access Groups', 'Content Types', 'Contracts', and 'Events'. The main area is titled 'Ripple Effect H264 MEZ | Offering Permissions | default'. A 'Modify Selected Offering Permissions' dialog box is open, showing the following fields:

- Offering Permission: Full Access
- Start Time: 2021-01-01 00:00:00 PST
- End Time: 2021-12-31 00:00:00 PST
- Geo Restriction: Unrestricted (selected), United States

Buttons for 'Update Selected Offerings' and 'Remove Selected Offerings' are visible at the bottom of the dialog. Below the dialog, there are buttons for 'Add Offering Permissions', 'Select All', and 'Clear Selected', along with a 'Filter Offerings...' search box. A table of offerings is visible below, with one row highlighted in blue:

Offering	Payout Formats	Permission	Geo Restriction	Start Time	End Time
watermarked	dash-clear, dash-widevine, his-aes128, ...	Full Access	unrestricted	1/1/2021, 24:00 PST	12/31/2021, 24:00 PST

This screenshot shows the same Eluvio interface as above, but with the 'Modify Selected Offering Permissions' dialog box closed. The table of offerings is now visible, with one row highlighted in blue:

Offering	Payout Formats	Permission	Geo Restriction	Start Time	End Time
watermarked	dash-clear, dash-widevine, his-aes128, ...	Full Access	unrestricted	1/1/2021, 24:00 PST	12/31/2021, 24:00 PST

At this stage the two titles were visible within any front end application using the site object and payout APIs providing valid authorization. Eluvio set up two sample applications for this: the Site Sample for desktop and mobile browser and the Eluvio TVOS sample application (see github.com/eluv-io for full details and open source to these applications).

ML Tagging of the Ingested Content

The Content Fabric includes a ML Video Understanding service based on deep learning that provides the option to tag ingested content identifying celebrities, logos, landmarks, objects and activities, detecting shot and scene boundaries, and providing speech-to-text translation. The models are native to the Content Fabric, and the resultant frame and segment level tags are stored as timecode metadata within the Content Object and are viewable within the Video Editor application in this workflow, the tagger was run on the H.264 ABR Mezzanine. One of the key scene speech-to-text translations is shown in the diagram below.

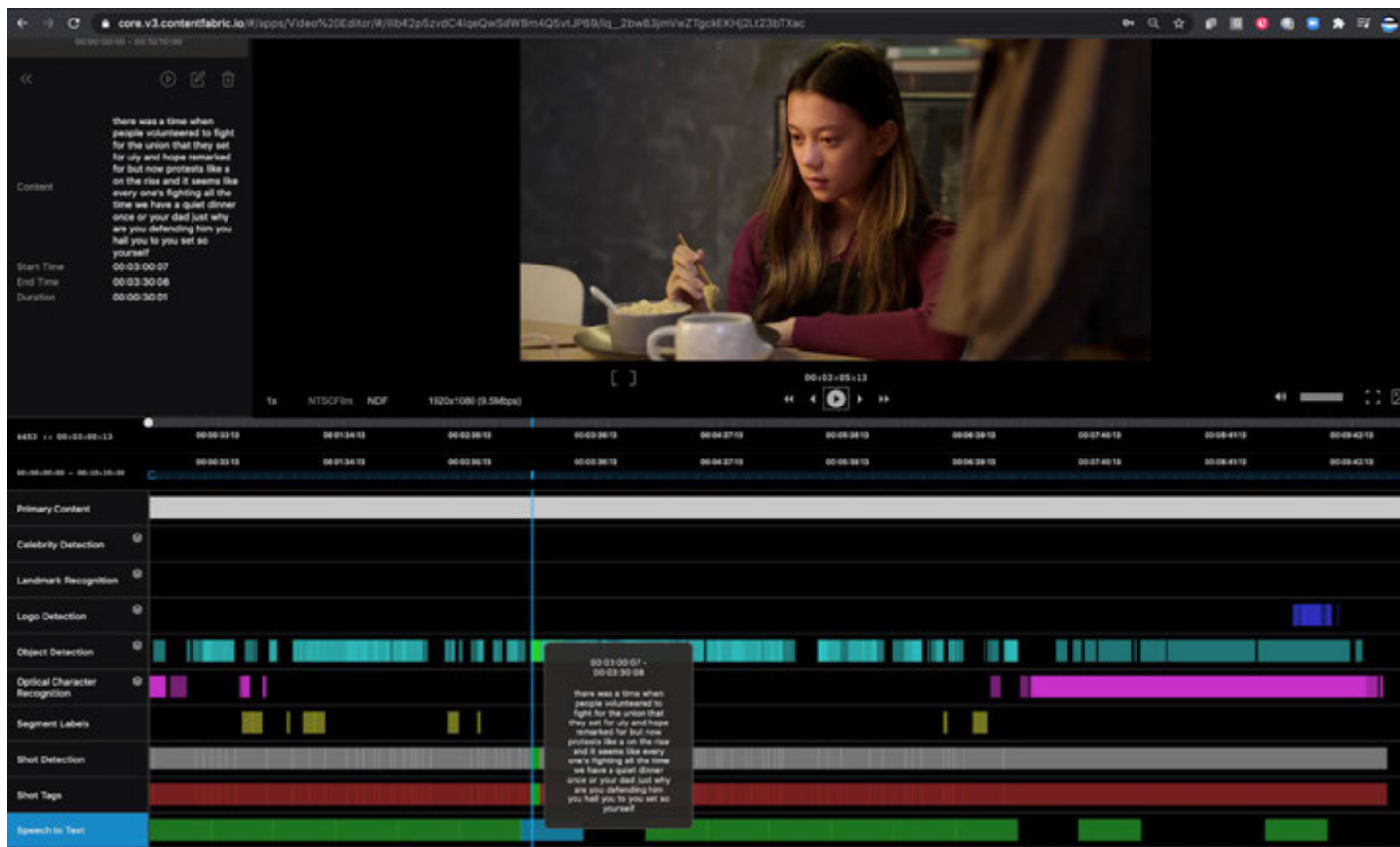

Conclusions and Viewing

This workflow illustrates the practical capabilities of a just-time-time secure publishing, authorization, and high quality screening of finished and near-finished content, without the encumbrances (time, complexity, and cost) of traditional cloud and CDN workflows. The end-to-end screening can actually be completed within hours of final availability of the content, and without compromising quality, reach, or security. This workflow is also a practical demonstration of the state of the art in the supply chain that when scaled up can dramatically accelerate time to market and reduce costs given the volumes of content at play today.

SAFETY ON SET

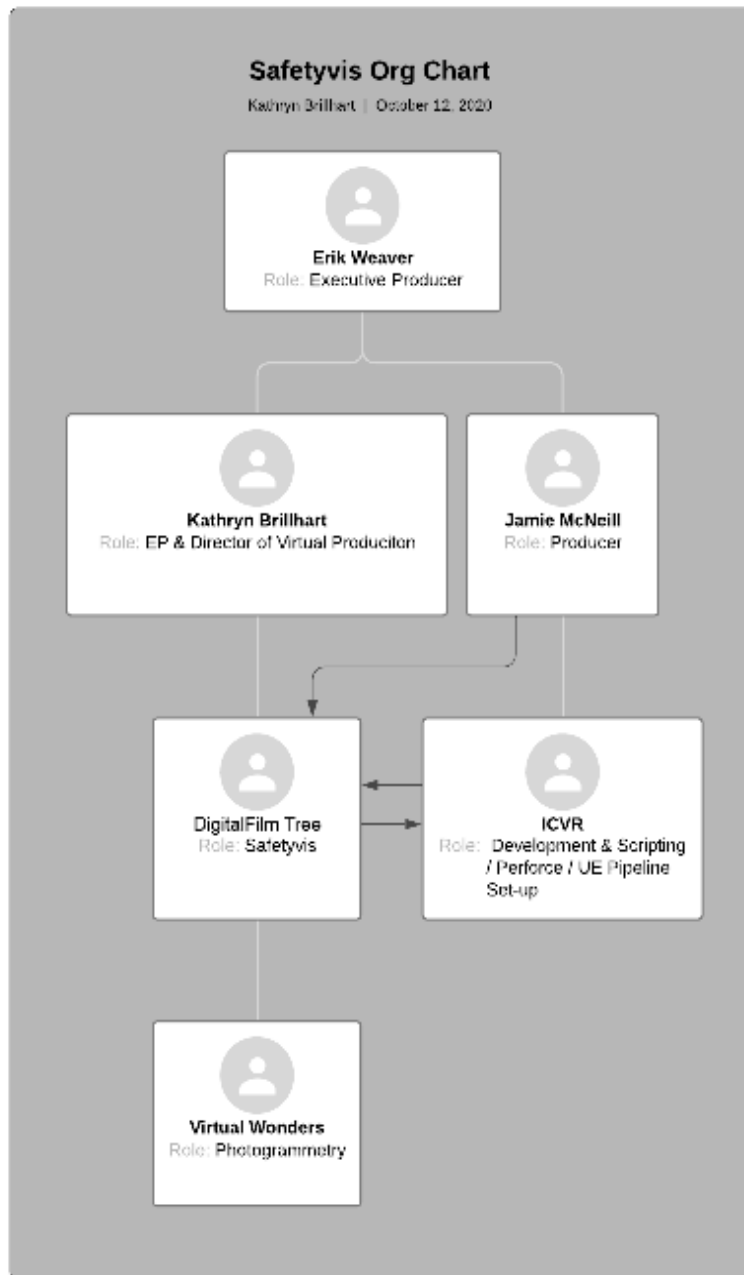

COVID-19 SAFETY DEBRIEF

COVID safety was one of the primary use cases on *Ripple Effect*. Back in June, after reading through around 20 different published COVID recommendations from various U.S. states, international countries, and industry unions, we compiled the information into an Excel matrix with over 350 easily categorized controls. This matrix provides a comprehensive overview of how different locations and groups are handling COVID production. And it was the fundamental reference tool we used to put together the list of *Ripple Effect* protocols. In collaboration with Michael Chambliss, a representative of the Local 600, and Catherine Shin, our COVID Safety Officer, we assembled a list of protocols that we thought would best fit our production scale to create a safe yet efficient set experience.

Safetyvis

We worked with two different companies to develop and test Safety Visualization “Safetyvis” technology, to plan, test, and communicate certain aspects of facility layout and personnel flow that we intended to have in place going into production.

We collaborated with ICVR to create a valuable safety tool that allows you to plan your production to scale utilizing LiDAR scans. With scale-accurate zone creation and customizability for specific shot set-ups, you can plan a day’s production before even stepping on set and export the overheads for crew distribution.

And expanding on the layouts created with ICVR’s safety tool, DigitalFilm Tree developed narrative walkthroughs of these LiDAR-scanned locations, following cast, crew, or personnel as they go through their process on set. These narratives intended to help production iterate on and communicate set operation methods using real-time techniques.

THE TEAM

Jamie McNeill - Producer
Brendan Bennett - Producer
Damon Laguna - Producer
Catherine Shin - COVID Safety Officer

PART I - THE PLAN

Pre-Set

Before arriving on set for the first time, all crew members were tested with a PCR COVID test, not an antibody blood test. We were performing weekly testing for our crew, and since no cast member worked for more than two consecutive days in a given week, we performed weekly testing for the cast. Whereas the crew just needed to be tested within the last 7 days, the cast was required to be tested 24-48 hours in advance since they would be unmasked on set.

We used two different vendors for testing: Ultimate DX and MiraDX. Ultimate DX provided PCR tests that were self-administered by the patient using a cheek swab method (the same as LA County Curative Testing), which gave us same-day results. These tests were incredibly convenient for production and the cast/crew. Still, some user error elements remained if the test was not taken in front of a COVID safety team member to verify it was done correctly. Our other provider, MiraDX, provided PCR oropharyngeal throat tests that required administering by a CA registered nurse. These tests were highly accurate but needed a more extensive infrastructure to accomplish. If a visitor or crew member did not want to get tested via production, we would not allow them to enter the set without proof of a negative result from LA County or a private healthcare provider within the previous seven days.

On top of testing, a digital COVID self-screening form was sent out every day, starting 14 days before production and ending 14 days after production. It included anyone who planned to enter the set for the duration of production and would ask questions about symptoms, travel, and contact with COVID-positive people. There was also a question that allowed anyone to bring up any COVID safety concerns, which was not anonymous.

Consequently, we implemented an anonymous form that any cast or crew member could fill out to bring up COVID safety concerns with the production and safety team. Whether anonymous or not, this feedback was provided to our team and allowed us to iterate our safety plans if someone noticed anything they felt could be improved.

On Set

When a crew member arrived on set for work, they would immediately line up at our INOVATIV checkpoint system, where their temperature was checked, and their clock-in time was recorded. If they had not already completed the self-screening, they would be required to do so before entry. This created an accurate log of who entered and exited the facility each day, in case contact tracing became necessary. Once checked in, each crew member was able to take various PPE from the checkpoint system if they did not already have their own.

From the moment anyone entered the facility, they were required to wear their facemasks at all times. The only exception to this was when eating, which was only permitted outside. Whenever there were actors on set, all crew members also on set were required to wear face shields in addition to masks. For any roles that required crew members to be close to unmasked cast members near-set, such as wardrobe or hair and make-up, they were required to wear face shields for the entire duration of their time at the facility.

While off-set, actors were given their own personal space away from the rest of the crew. Whenever they were not actively needed on set, they were required to be in this designated space to prevent any potential cross-contamination between cast and crew.

For lunches, all cast and crew were given food that was individually packaged. Rather than having a communal table, which could lead to a lot of potential contamination, we provided individual crafty bags. Each bag contained various snacks and water, which would supplement a typical crafty table and reduce the possibility of crew members eating out communal food sources. Eating was only permitted outside where there was ventilation. We set up pop-up tents, tables, and chairs so that everyone was seated six feet apart. We set up plastic dividers on each table during one lunch, which helped mitigate any spread of germs even more so. As for the cast, they would usually eat in a more isolated area of the space.

We provided multiple hands-free hand sanitizer stations and a hands-free handwashing station on set. Hand sanitizer stations were placed at all entrances and exits and close by set in high-traffic areas. And everyone on the crew was required to wash their hands with soap and water before eating lunch, as this is the best method to ensure cleanliness before consuming food.

One of the most challenging protocols to maintain on set was social distancing, primarily when many departments worked very closely and often crowded around monitors. We tried to reduce any congregations of people by implementing one-way routes into and out of the set and utilizing a social distancing tracking device called Set Buddy from Air Sheriff and Content Protection Experts. Twenty of our crew members wore the Set Buddy device, either via a belt-pack or lanyard, that would alert them via sound, vibration, or both, whenever they were within six feet of another crew member who had a device. We were able to program pods of the crew so that the device would not alert the holder if they came within six feet of someone else in their pod. This feature was especially useful for larger departments such as Camera, Grip and Electric, and Art.

Another critical element of our COVID safety was limiting the number of people we had on set using the remote workflow technology the Executive Producer & Head of Post and Production Technologies, Greg Ciaccio oversaw. This drastically reduced on-set crew numbers, allowing much work to occur near-set or off-set entirely.

PART II - WHAT HAPPENED?

During Pre-Production a few weeks before the start of principal photography, our Director of Photography notified us that he had a sore throat and had tested positive for COVID-19 via LA County. By this point, we had been working mostly remotely but had just begun to do some preliminary walk-throughs of the locations. Our DP was present for all of these walkthroughs and had potentially exposed some of the key crew members who were also present.

We immediately had the DP get tested twice more to ensure there was no false-negative. Once he got his second positive, we informed the crew of the situation. As we had been keeping track of who was on set and their respective in-and-out times via the log, we knew who was on set when the DP was present through contact tracing. We immediately tested all of the crew members who were in contact with him, and thankfully, all of them came back negative.

This proved two things. First, this positive case was not a result of the production. As we later found out, the DP had been working a part-time job in the evenings, and it is likely he contracted it from his work or through some other means. Secondly, this showed that the PPE, handwashing, and other COVID preventative measures had successfully mitigated transmission to anyone else on the crew who had come

in contact with the DP while he was sick.

After the DP tested positive, he decided to step off the project to focus on his recovery. We kept asking ourselves down the line during the hiring process: Who should be alerted about this positive case? Should we tell all the future cast and crew hires even though the DP is no longer on the project?

There were many back and forth discussions, but we ultimately decided that it was good to be transparent and not have someone learn about the positive case and feel we had been dishonest. When some crew members became aware of this information, they opted to leave the project because they were not comfortable working on a film that already had a positive case. However, for the crew members who stayed, this positive result early on in the process meant people were very aware of the dangers and were very conscious about the importance of safety on set.

Aside from this positive case, we had some protocols that worked effectively, while others did not. The safety protocols that worked well were the testing, the contact tracing, the check-ins at the beginning of each set day, the PPE, the crafty bags, and the avenues established for the crew to report their COVID concerns.

The most significant issues we ran up against were social distancing and communication. Often on set, the crew would be so focused on getting their job done that they would ignore social distancing and six-foot-spacing measures. There were several times where crew members would break the barrier to do their job, and that was something for which we were continually trying to find solutions.

One of the main reasons for this six-foot encroachment was that communication was difficult. Since the crew was wearing PPE and face shields, it was often tough to understand what people were saying. We tried to utilize walkies, but people often found it easier to move a little closer to hear one-another than to try and walkie someone who was standing a few feet away from them. While the Set Buddy device was able to help solve some of these issues, with limited units on our set, they had limited overall effectiveness. Some crew members would also mute the devices, as the vibration alert was much easier to ignore than the auditory alert.

Initially, we had a plan to have each of the departments have their own “Pod” or section where they would exist when they were not actively working on set. This plan was a great idea in principle, but the crew often would forget this and end up wandering around to other sections of the set for various reasons. There would also be many instances when someone from one department would be needed to work with another department to get things done efficiently. For example, the Production Designer needed to work with the G&E crew to rig up a practical chandelier. Additionally, when the shot was up, most of the crew wanted to watch the take from near the large monitor on set. We tried to combat this by having all unnecessary crew stand in the facility’s lobby and watch from a remote monitor there, but often the crew didn’t want to leave set as they might be needed to jump in on short notice.

Lunches were also another area in which we struggled to make sure there was enough space between everyone. Since everyone would be eating unmasked, we needed to have plenty of room between everyone and adequate ventilation to ensure that the lunches would not be a place where the crew could pass the virus to one another. To do this, we needed a lot of space between everyone, which meant a lot of tents and production infrastructure. Ultimately, due to our large crew and limited infrastructure, this became a stressful time on each production day.

Going through this experience, we have plenty of ideas of how we would adjust and iterate the safety protocols moving forward on future productions.

PART III - WHAT WE WOULD CHANGE

In an ideal world, we would pay for the crew's time for the entirety of the prep and production, rather than having the crew come to set and then returning home at the end of each day. For example, having all cast and crew stay in a production-sanctioned hotel. This would treat the production as its own bubble, which would ensure a limited chance of exposure to the virus outside of set since production has tabs on where everyone will be. Of course, this is challenging for many reasons.

One of the biggest lessons we learned is that there is a correlation between time and safety. The more days of prep and production that production has, the more likely the set will be run safely, as dedicated time can be put aside for safety precautions. Since we only had four shoot days and a limited number of prep days, everyone cut corners and tried to be as efficient as possible to make their days. Given more shoot and prep days, there would be less of a need to rush to get all the coverage needed in a short period, and as a result, people could focus on safety over efficiency. While more days on set means more chances of exposure, the way the crew behaves on set for those days will have a massive impact on limiting contraction possibilities if an outbreak were to occur.

Time constraints also presented limitations for effective onboarding and individualized safety education for crew members. Provided dedicated time for the safety team to address optimal safety training and offer opportunities for individuals to handle any personal health, safety, and environmental concerns could have reduced the cases of breaking protocols on set and opened up opportunities for crew to mitigate their anxiety and stress of returning to work during this pandemic.

In the world of local hires and having cast and crew go to and from set every day, we would recommend testing three times a week at minimum. Longer gaps between testing increase the chances that someone could have contracted the disease and not have it reported in data.

Some crew opted to use their personal face coverings, which are not all as safe as 3-ply surgical masks. This resulted in some crew members feeling uncomfortable, and in the future, we would want to enforce the usage of N95 masks, which are even safer than 3-ply surgical masks.

One of our locations did not have adequate air conditioning, which meant there was not a lot of ventilation on set. If we were able to bring in air conditioning or at a location with this built-in, then the set could have been safer as there would have been airflow throughout and, therefore, a lower chance of passing on the virus.

Looking back, we could have had a more dedicated safety team to enforce these protocols on set. We had Producers and the single COVID Safety Officer doing so, but with a larger dedicated team, we could have been stricter with ensuring that our crew was following protocol.

Other than our first DP who contracted COVID outside of set early on, we are very proud and relieved to say that nobody on this production contracted or spread the disease while on set. We think that while our protocols worked well on our level, and while they are not perfect for the reasons described, we would love to see them improved, amended, and expanded to fit the scope of projects much larger than *Ripple Effect*.

APPENDIX

5G

Next-generation cellular protocol enabling high-speed cellular data communication - G. Ciaccio

Ambient Light

For computer graphics (CG), a directionless light source that uniformly distributes light in all directions, illuminating objects equally regardless of their surface orientation. CG ambient lighting is used as an inexpensive way to simulate the indirect illumination that occurs in real world when light bounces off of other objects in the environment. - The VES Handbook of Visual Effects

Asset Optimization

The level of detail used to create a CGI asset can have significant implications on the performance of the rendering system(s). Assets used in traditional VFX rendering pipelines (e.g. Arnold, or Renderman) are typically created at the highest possible fidelity, and may take multiple seconds, minutes, or even hours to render a single frame, whereas assets used in realtime rendering applications must be able to render in fractions of a second (e.g. at production frame rates). For this reason it is important to optimize assets for their intended use. See Decimation. - N. Mitchell

Atmospheric Effects

A depth cue that causes objects to decrease in contrast as they move into the distance. - The VES Handbook of Visual Effects

Bake In

Term used to mean that whatever settings, composite layers, color, animation, and so on that have been used, have been permanently set in the shot. For example, "Do not bake in any bad animation or you will never be able to change it." - The VES Handbook of Visual Effects

Baked Out

To output in a format that is fixed. In this case the model is no longer able to be animated but exists essentially as a 3D model for each frame. - The VES Handbook of Visual Effects

Banding

An artifact that appears in areas of a color gradient where the lack of sufficient color resolution causes noticeable bands instead of a smooth transition. - The VES Handbook of Visual Effects

Blueprint

Script created from the Blueprint visual scripting language in UE4 which defines how an asset interacts. - Epic Games Virtual Prod Field Guide

CG Asset

A computer generated object.

Data Capture

The capture of important details during principal photography such as photographic reference, lighting reference, LiDAR scans, camera metadata, etc. - Epic Games Virtual Prod Field Guide

De-lighting

The process of removing shadows and specular highlights from photographs taken for photogrammetry workflow. Removing shadows and specular highlights from each image reveals the subject's true color and prepares them for dynamic, interactive real-time lighting in a game engine. - K. Brillhart

Decimation

The process of throwing away unnecessary information when reducing the size of an image. - The VES Handbook of Visual Effects

The reduction of detail to optimize an asset's real-time performance; a key difference between assets created for real-time versus post-production animation. - Epic Games Virtual Prod Field Guide

Dynamic Range

The range of brightness values in a scene or an image, from brightest to darkest, often expressed as a ratio. In a digital image, the total number of different colors in the image. - The VES Handbook of Visual Effects

Final Pixel

Images of high enough quality to be the final output for film or TV. In a traditional linear pipeline, final pixel was only possible at the end of post-production. In virtual production, final pixel can sometimes be achieved in camera during shooting. - Epic Games Virtual Prod Field Guide

Fix it in Post

A phrase commonly used when time and/or conditions prohibit the ability to shoot a scene exactly as intended. Rather than delaying the production, a decision is made to shoot as quickly as possible and correct any problems during post-production, usually using visual effects techniques. Usually an expensive solution that defers costs to post-production. It is highly unusual for the production to send part of their budget to the post-budget to cover this expense. - The VES Handbook of Visual Effects

Frustum

Term commonly used in computer graphics to describe the 3D region that is visible on the screen (which is formed by a clipping pyramid); in particular, frustum culling is a method of hidden surface determination. - The VES Handbook of Visual Effects

Game Engine

A software-development environment designed for people to build video games. Developers use game engines to construct games for consoles, mobile devices, and personal computers. The core functionality typically provided by a game engine includes a rendering engine ("renderer") for 2D or 3D graphics, a physics engine or collision detection (and collision response), sound, scripting, animation, artificial

intelligence, networking, streaming, memory management, threading, localization support, scene graph, and may include video support for cinematics. - The VES Handbook of Visual Effects

A software development environment designed for the creation of real-time interactive content, initially intended for video games but now used in many other applications. - Epic Games VP Field Guide

Global Illumination

A general term used to describe the modeling of all of the reflected and transmitted light that originates from every surface in a scene. - The VES Handbook of Visual Effects

GPU

Abbreviation for graphics processing unit. It is a specialized electronic circuit designed to rapidly manipulate and alter memory to accelerate the creation of images in a frame buffer intended for output to a display device. Many visual effects tools are processed in GPU rather than CPU (Central Processing Unit). - The VES Handbook of Visual Effects

Horizon Line

Is exactly what it sounds like. However, it ends up being something you spend a lot of time and effort managing in a virtual production project using LED walls. Ensuring that the virtual environment's horizon line and the associated vanishing point doesn't conflict with camera angles and foreground elements of a scene can be tricky. Further, as the camera starts to move, ensuring the horizon doesn't drift in a way that makes the background feel as if it is detached from the reality in the foreground is something of an art, and critical to scene believability. - N. Mitchell

In-Camera Effects

Visual effects that are accomplished solely during principle photography, involving no additional post-production. - The VES Handbook of Visual Effects

Latency

The delay between when a signal is sent and when it is received at its destination; experts consider under 10 milliseconds of latency to be critical for real-time camera operation. - Epic Games Virtual Prod Field Guide

LED (light emitting diode)

A semiconductor light source that emits light when current flows through it. The color of the light is determined by the energy required for electrons to cross a layer of light-emitting phosphor on the semiconductor device. - The VES Handbook of Visual Effects

LED Wall

A relatively large array of modular LED panels used as a virtual background, for reflections or as a lighting source to simulate a real environment. - G. Ciaccio

LiDAR (Light Imaging Detection and Ranging)

LiDAR is a surveying method that measures distance to target by illuminating the target with laser light and measuring the reflected light with a sensor. Differences in laser return times and wavelengths can then be used to make digital 3D representations of the target. - The VES Handbook of Visual Effects

LOD (Level of Detail)

A lower-resolution representation of an object that can be used to improve performance when an asset is distant from the camera. Typically, several different levels of detail will be produced, each at a different

resolution. LODs are produced from a high-resolution object through decimation”. - Epic Games Virtual Prod Field Guide

LUT (Look Up Table)

A mathematical modification table that translates between a raw camera image and a desired display appearance. - Epic Games Virtual Prod Field Guide

Moire

The nonlinear interaction of the optical patterns of lines creates a real and visible pattern of roughly parallel dark and light bands, the moiré pattern, superimposed on the lines. - Figueiredo, Mário; Zerubia, Josiane (2001). Jain, Anil K. (ed.). Energy Minimization Methods in Computer Vision and Pattern Recognition. Springer. ISBN 9783540425236.

Footage captured by digital cameras using LED walls as backgrounds often exhibit moiré patterns. Since both the LED display and the digital camera use a scanning technique to produce or to capture pictures with horizontal scan lines, the conflicting sets of lines cause the moiré patterns. To avoid the effect, the digital camera can be aimed at an angle to the Led wall. Angle to wall may vary and needs testing prior to shoot. The configuration of the LED wall, along with additional curvature in the wall will impact moiré results. - K. Brillhart

Moiré effect is a visual perception that occurs when viewing a set of lines or dots that is superimposed on another set of lines or dots, where the sets differ in relative size, angle, or spacing. - Hongkong Cinstar Electronics Co., Limited

Motion/Performance Capture

Motion Capture is the practice of digitizing the motions of a human being or animal for use in analysis or animation. In its earliest days, mocap could capture only broad motion, which made it suitable for body motion only. More recently, motion capture systems have become sensitive enough to capture subtle details in the face and fingers, giving rise to performance capture. - Choosing a real-time performance capture system - Hlbbits, Unreal Engine, Epic Games (2020)

A technique whereby an individual being’s performance is captured and translated for use in driving a CG being’s performance. - The VES Handbook of Visual Effects

Nit

A measurement of how much light a display screen sends to your eyes within a given area. It is equivalent to 1 candela per square meter (1 nt = 1 cd/m²). - Epic Games Virtual Prod Field Guide

OSC

On-screen controls used for controlling real-time game engine attributes via tablets, etc. Can also refer to Open Sound Control, a protocol for audio communication. - Epic Games Virtual Prod Field Guide

Parallax

The perceptual difference in an object’s location or spatial relationship when seen from different vantage points. We see depth via parallax and stereo vision. - The VES Handbook of Visual Effects

Perspective

A term relating to the size and depth relationships of the objects in the scene. - The VES Handbook of Visual Effects

Photogrammetry

A method in which textured 3D geometry is created based on the analysis of multiple 2D images taken from different viewpoints. - The VES Handbook of Visual Effects

Previs

“Previs” or “Previsualization” in the context of modern filmmaking is the process of creating digital representations of a shot, scene, or sequence before it’s actually filmed. These elements include, but are not limited to, camera and actor blocking, asset creation, layout, set and lighting design. Previs can be as straightforward as storyboards and animatics or be more complex such as motion capture driven animation, and “virtual scouting.” - Halon Entertainment

Previs is a collaborative process that generates preliminary versions of shots or sequences, predominantly using 3D animation tools and a virtual environment. It enables filmmakers to visually explore creative ideas, plan technical solutions, and communicate a shared vision for efficient production. - The VES Handbook of Visual Effects

Ray Tracing

A rendering technique for generating an image by tracing the path of light as pixels in an image plane and simulating the effects of its encounters with virtual objects. - Epic Games Virtual Prod Field Guide

Real World Scale

A system or series of marks used for measuring or registering a virtual (CG) world based on the physical world. Scale accurate assets are essential for any visual effects project. Using real-world scale ensures that a model can be ingested into another company or artist’s pipeline immediately without scaling issues. It is expected that the model can be placed into a scene and have it match scale with minimal editing. If a model is not made to real-world scale an artist will have to scale and tweak it themselves, either by taking the time to look up measurements or by estimating, slowing down production and possibly ruining the impact of their scene.

Real-Time

Displaying a sequence of images at the same speed as they will be viewed in their final form.

Computational processing that appears to be nearly instantaneous. - The VES Handbook of Visual Effects

Real-Time Rendering

The translation of a scene into display pixels fast enough for instantaneous playback at real-time (live) speeds. In contrast, traditional offline rendering may take minutes or even hours to produce each frame, with 24 frames required to display a second’s worth of animation. - Epic Games Virtual Prod Field Guide

Render

The process of creating a synthetic image from a 3D data set. - The VES Handbook of Visual Effects

Safetyvis

The visualization of safety aspects of a production environment designed to protect the health of related crew.

Scan Line

A scan line (also scanline) is one line, or row, in a raster scanning pattern, such as a line of video on a cathode ray tube (CRT) display of a television set or computer monitor.

Scanning

The process of capturing an object or environment for the purposes of digital reproduction. - G Ciaccio

Smart Stage

A stage purpose-built for virtual production including LED walls, tracking systems, and real-time capabilities. - Epic Games Virtual Prod Field Guide

Techvis

“Techvis” or “Technical Visualization” is the process of determining the technical requirements to produce a given shot, scene or sequence. Techvis is the translation of previs into physical production. - Halon Entertainment

Incorporates and generates accurate camera, lighting, design, and scene layout information to help define production requirements. This often takes the form of dimensional diagrams that illustrate how particular shots can be accomplished, using real world terms and measurements. - VES Handbook of Visual Effects

Using 3D assets to perform technical analysis on scenes: camera type, lenses, distances, set requirements, stunts, and any other information needed to physically shoot your story before you get on set. - Epic Games VP Field Guide

Tessellation

Tessellation or tiling of the plane: A collection of plane figures that fills the plane with no overlaps and no gaps. One may also speak of tessellations of the parts of a plane or of other surfaces. Generalizations to higher dimensions are also possible. - The VES Handbook of Visual Effects

Two Point Perspective

Linear perspective in which parallel lines along the width and depth of an object are represented as meeting at two separate points on the horizon that are 90 degrees apart as measured from the common intersection of the lines of projection. - Miriam Webster’s Dictionary

Universal Scene Description (USD)

Pixar’s open-source scene interchange and assembly format, widely adopted in the film industry. - Epic Games Virtual Prod Field Guide

Viewing Frustum

The region of space in the modeled world that may appear on the screen; it is the field of view of the notional camera. The exact shape of this region varies depending on what kind of camera lens is being simulated, but typically it is a frustum of a rectangular pyramid (hence the name). The planes that cut the frustum perpendicular to the viewing direction are called the near plane and far plane. Objects closer to the camera than the near plane or beyond the far plane are not drawn. Often, the far plane is placed infinitely far away from the camera so all objects within the frustum are drawn regardless of their distance from the camera. Also referred to as a view frustum. - The VES Handbook of Visual Effects

Virtual Art Dept (VAD)

VAD is a digital-only version of the Art Department. - Halon Entertainment

Produces all asset materials—such as characters, props, and sets—in low resolution for traditional previs, VFX post-production, and virtual production. - Epic Games VP Field Guide

Virtual Camera (vCam)

A camera in the game engine that can be driven using a device such as an iPad or traditional filmmaking equipment via encoders/trackers. - Epic Games Virtual Prod Field Guide

Virtual Cinematography

Virtual cinematography is the application of cinematographic principles to a computer graphics scene, providing solutions for cinematographers to compose and shoot as if it were live action. - The VES Handbook of Visual Effects

Virtual Location Scouting

The use of a real-time engine to depict either a location or a physical set on a display screen or via a shared VR session. - Epic Games Virtual Prod Field Guide

Virtual Production

The cross section between physical and digital worlds. VP lets directors work on a physical stage but use real-time technology to view and interact with virtual environments and characters. - Epic Games Virtual Prod Field Guide

Visual Effects

A broad term that refers to anything that cannot be captured using standard photographic techniques. Visual effects can be accomplished in-camera or via a number of different optical or digital post-production processes. Visual effects are a subcategory of special effects. - The VES Handbook of Visual Effects

Visualization

The rendering of an object or scene for simulation purposes. Visualization processes help to inform filmmakers by using digital tools in order to represent a shot or scene. - G Ciaccio

Volume

For this purposes of this paper, a term that broadly describes techniques used to capture and recreate physical assets as CG assets in three dimensions for viewing in a virtual or mixed reality. - K. Brillhart

The physical space in which performance capture is recorded. - Epic Games VP Field Guide

Volumetric Capture

A term that broadly describes techniques used to recreate physical assets as CG assets in three dimensions for viewing in a virtual or mixed reality. - Kathryn Brillhart

W-Fi 6

Next-generation Wi-Fi protocol enabling high-speed LAN data communication. - Greg Ciaccio

